

ORIGINALS BY OKE



APPLICATION SAMPLES AND PARTS
FOR FURNITURE

VERSION 2021



INHALTS- VERZEICHNIS/ CONTENTS

04

OKE STELLT
SICH VOR/
OKE INTRODUCE
THEMSELVES

04 →
ÜBER UNS/
ABOUT US

05 →
FAKTEN/
FACTS

06

POLSTERMÖBEL/
UPHOLSTERED
FURNITURE



08 → #01 – #03
KOPFSTÜTZE/
HEADREST

11 → #04 – #14
RÜCKENLEHNE/
BACKREST

21 → #15 – #26
ARMLEHNE/
ARMREST

30 → #27 – #38
SITZFLÄCHE/
SEAT

42 → #39 – #56
GESTELL/
FRAME

60

OBJEKTMÖBEL/
CONTRACT
FURNITURE

62 → #57 – #65
RÜCKENLEHNE/GESTELL
BACKREST/FRAME

68 → #66 – #75
SITZFLÄCHE/
SEAT



76

BÜROMÖBEL/
OFFICE
FURNITURE



78 → #76 – #77
KOPFSTÜTZE/
HEADREST

79 → #78 – #84
RÜCKENLEHNE/
BACKREST

86 → #85 – #87
SITZFLÄCHE/
SEAT

90

RECLINER/
RECLINER



92 → #88 – #89
KOPFSTÜTZE/
HEADREST

94 → #90 – #94
RÜCKENLEHNE/
BACKREST

98 → #95 – #101
ARMLEHNE/
ARMREST

104 → #102 – #111
SITZFLÄCHE/
SEAT

114

BETTEN/
BEDS



116 → #112 – #119
KOPFTEIL/
HEADBOARD

123 → #120 – #123
WANGE/
SIDEBOARD

128

BILDQUELLEN/
IMPRESSUM
IMAGE
SOURCES/
IMPRINT

128 →
BILDQUELLEN/
IMAGE SOURCES

129 →
IMPRESSUM/
IMPRINT

OKE STELLT SICH VOR/ OKE INTRODUCE THEMSELVES

Die OKE Unternehmensgruppe entwickelt und produziert anspruchsvolle technische Kunststoffkomponenten vor allem für die Automobil-, Elektronik- und Möbelindustrie. Auch in intelligenter Gebäudetechnik und der Agrarindustrie werden unsere Bauteile eingesetzt. Zur Unternehmensgruppe gehören insgesamt 15+1 (OKE Vietnam Eröffnung in 2022) Einzel-unternehmen, die weltweit in logistischer Nähe zu den Kunden angesiedelt sind.

Mit 1,800 Mitarbeitern bilden wir die gesamte Prozesskette von der Idee bis zum fertigen Bauteil oder einer kompletten Baugruppe ab. Unsere Kernkompetenzen sind Extrusion, Spritzguss, Maschinen- und Anlagenbau sowie Werkzeugbau. Je nach Marktzugang und Kundenstruktur kombinieren wir diese Fertigungstiefen, um immer eine ganzheitliche Lösung zu liefern.

The OKE Group develops and produces technically advanced plastic components for the automotive, electronics and furniture industries. Our components are also used in intelligent building technology and the agricultural industry. The group is made up of 15+1 (OKE Vietnam opening in 2022) individual companies, which are located all over the world in logistical proximity to the customers.

With 1,800 employees we cover the whole process chain from the idea to the completed part or component. Our core competencies are extrusion, injection moulding, machinery and plant engineering, and tool manufacturing. Depending on market access and customer structure, we combine these depths of manufacturing in order to always deliver a holistic solution.



OKE HEADQUARTER IN
HÖRSTEL/OKE HEADQUARTERS
IN HÖRSTEL

FAKTEN/ FACTS

1.800 

MITARBEITER/
EMPLOYEES

15+1* 

EINZELUNTERNEHMEN/
INDIVIDUAL COMPANIES

150 

EXTRUSIONSLINIEN/
EXTRUSION LINES

3x 

EIGENER WERKZEUGBAU/
OWN TOOL MAKING



12+1*

STANDORTE WELTWEIT/
LOCATIONS WORLDWIDE



200

MIO. € UMSATZ/MIO €
TURNOVER



200

SPRITZGUSSMASCHINEN/
INJECTION MOULDING
MACHINES



VIELE AUSZEICHNUNGEN
FÜR PRODUKTE, PROZES-
SE UND EIN MODERNES
ARBEITSUMFELD/MANY
AWARDS FOR PRODUCTS,
PROCESSES AND A MODERN
WORKING ENVIRONMENT

*Unser neuer Standort in Vietnam. Eröffnung in 2022

*Our new location in Vietnam. Opening in 2022



POLSTERMÖBEL

Sitzen, liegen, lümmeln, chillen, loungen oder abhängen. Kein Problem mit unserer Produktgruppe Unterfederung.

UPHOLSTERED FURNITURE

Sitting, lying, slouching, chilling, lounging or hanging out. No problem with our suspension product group.

POLSTER- MÖBEL/ UPHOLSTERED FURNITURE

Mit unseren Kunststoffkomponenten erweitern wir die Möglichkeiten unserer Kunden in der Entwicklung und Fertigung von Polstermöbeln. Unsere Lösungen ermöglichen besondere Designs, sparen wertvolle Rohstoffe, verringern Produktionszeit und sorgen bei der Unterpolsterung für einen hohen Sitzkomfort. Bei der Zusammenarbeit mit unseren Kunden gehen wir immer sehr genau auf ihre Anforderungen ein und entwickeln auf Wunsch auch ganz individuelle Lösungen.

With our plastic components, we expand our customers' capabilities in the development and manufacture of upholstered furniture. Our solutions allow for special designs, save valuable resources, reduce production time and provide padding for genuine seating comfort. In collaboration with our customers, we are always prepared to meet their precise requirements, and develop fully customised solutions according to their wishes.

08 → #01 – #03
KOPFSTÜTZE/
HEADREST

30 → #27 – #38
SITZFLÄCHE/
SEAT

11 → #04 – #14
RÜCKENLEHNE/
BACKREST

42 → #39 – #56
GESTELL/
FRAME

21 → #15 – #26
ARMLEHNE/
ARMREST

#01

KOPFSTÜTZE - HEADREST

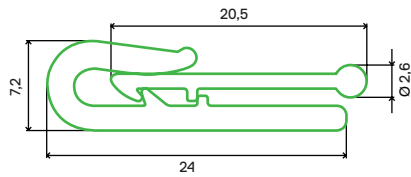



2298-000

2297-000



#01 VERSCHLUSSSYSTEM/ LOCK SYSTEM

NO.	DESCRIPTION	PU	DIMENSIONS	PROD. OVERVIEW
2298-000	 Verschlussprofil mit Widerhaken lock profile with barb	150 Stück 150 pcs.	Länge: 1.200 mm length: 1,200 mm	Nr. 128 no 128
2297-000	 Gegenleiste mit Kugel counter-bar with ball	300 Stück 300 pcs.	Länge: 1.200 mm length: 1,200 mm	Nr. 127 no 127

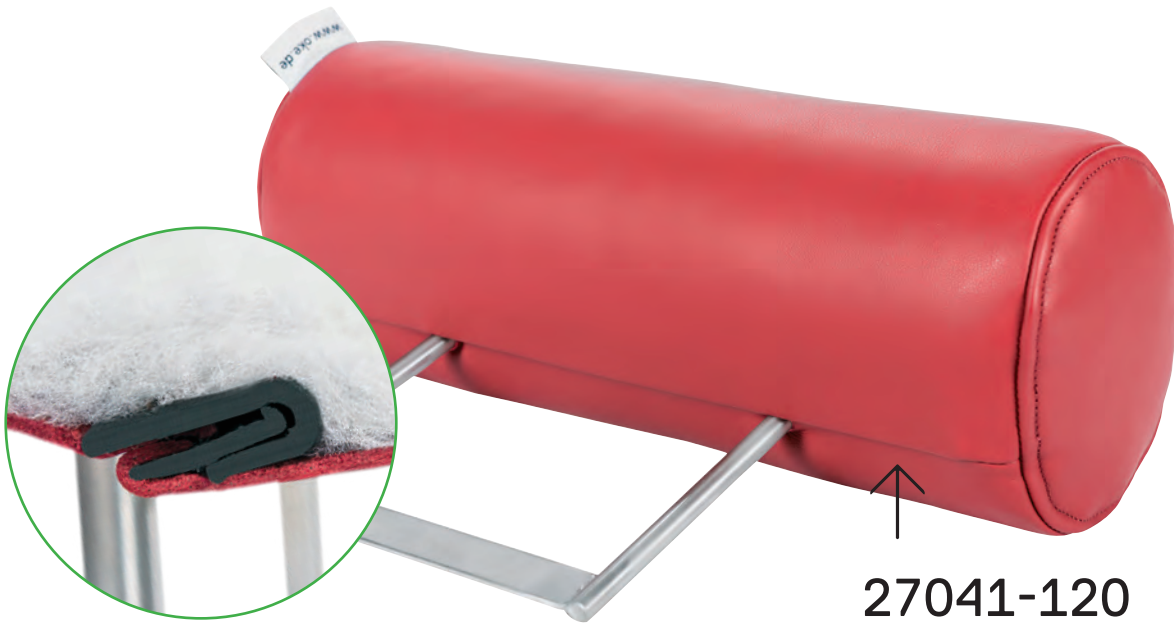

27041-120
23115-999

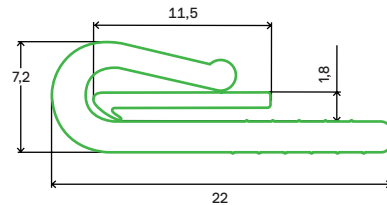

#02 VERSCHLUSSSYSTEM/ LOCK SYSTEM

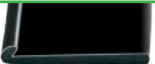
NO.	DESCRIPTION	PU	DIMENSIONS	PROD. OVERVIEW
27041-120	 Verschlussprofil ohne Widerhaken lock profil without barbs	150 Stück 150 pcs.	Länge: 1.200 mm length: 1,200 mm	Nr. 121 no 121
23115-999	 Gegenleiste counter-bar	Rollen à 500 m rolls at 500 m each	Breite: 11,5 mm width: 11.5 mm	Nr. 144 no 144



2271-000

23125-999

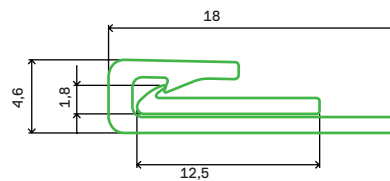
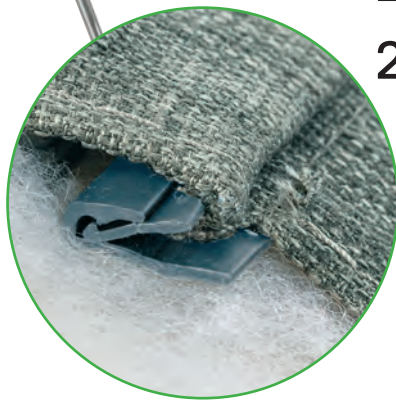

#03 VERSCHLUSSSYSTEM/ LOCK SYSTEM

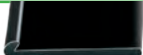
NO.	DESCRIPTION	PU	DIMENSIONS
2271-000	 Verschlussprofil mit Widerhaken lock profile with barb	250 Stück 250 pcs.	Länge: 1.200 mm length: 1,200 mm
23125-999	 Gegenleiste counter-bar	Rollen à 500 m rolls at 500 m each	Breite: 12,5 mm width: 12.5 mm



20237-M000
23115-999

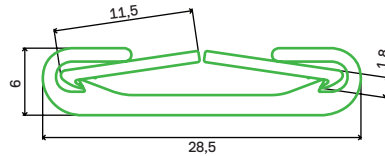

#04 DOPPELVERSCHLUSSSYSTEM/ DOUBLE LOCK SYSTEM

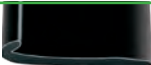
NO.	DESCRIPTION	PU	DIMENSIONS
20237-M000	 <p>Verschlussprofil für zwei Stoffbahnen, ohne Einschnitte lock profile for two fabric panels without cuts</p>	50 Stück 50 pcs.	Länge: 1.200 mm length: 1,200 mm
23115-999	 <p>Gegenleiste counter-bar</p>	Rollen à 500 m rolls at 500 m each	Breite: 11,5 mm width: 11.5 mm

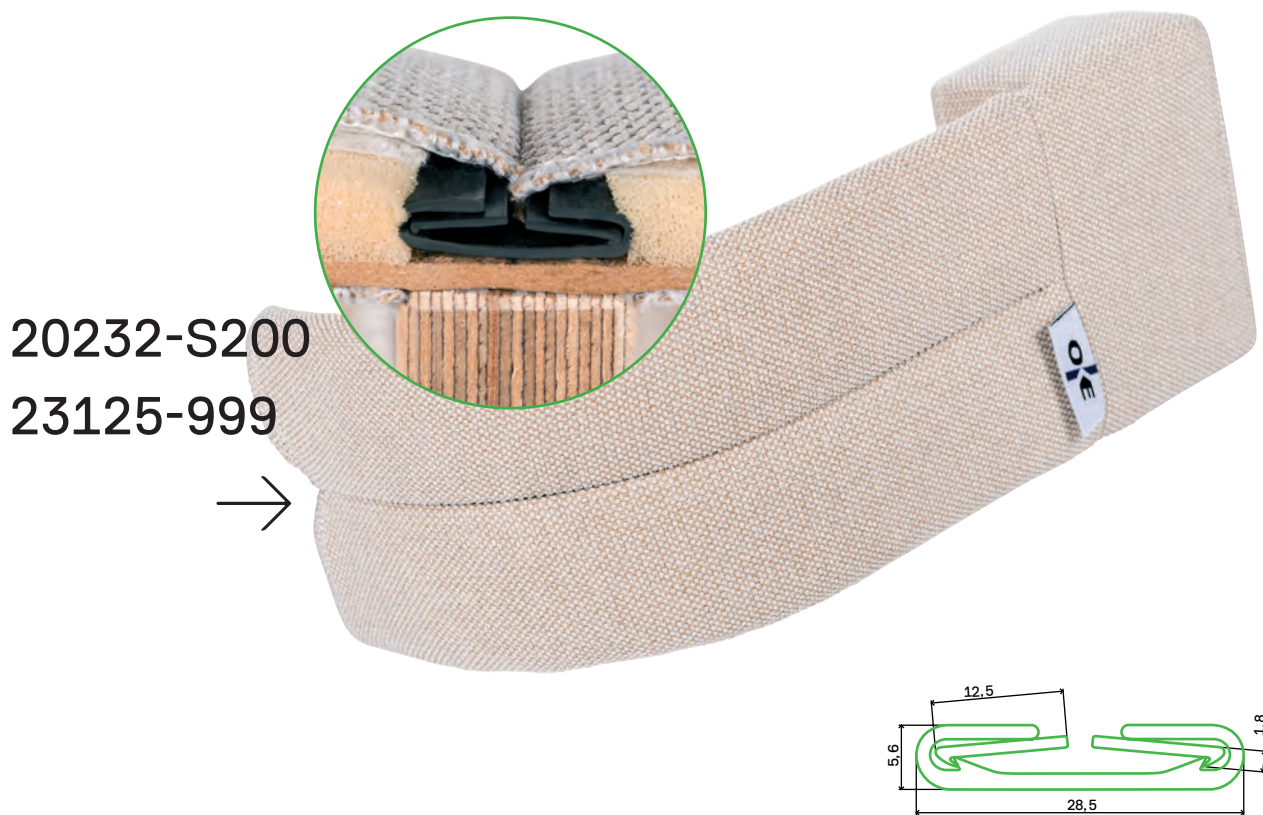

#05 DOPPELVERSCHLUSSSYSTEM/ DOUBLE LOCK SYSTEM

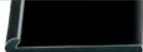
NO.	DESCRIPTION	PU	DIMENSIONS
20232-S200	 Verschlussprofil für zwei Stoffbahnen, mit Einschnitten lock profile for two fabric panels with cuts	50 Stück 50 pcs.	Länge: 1.200 mm length: 1,200 mm
23125-999	 Gegenleiste counter-bar	Rollen à 500 m rolls at 500 m each	Breite: 12,5 mm width: 12.5 mm

20233-S400
23115-999

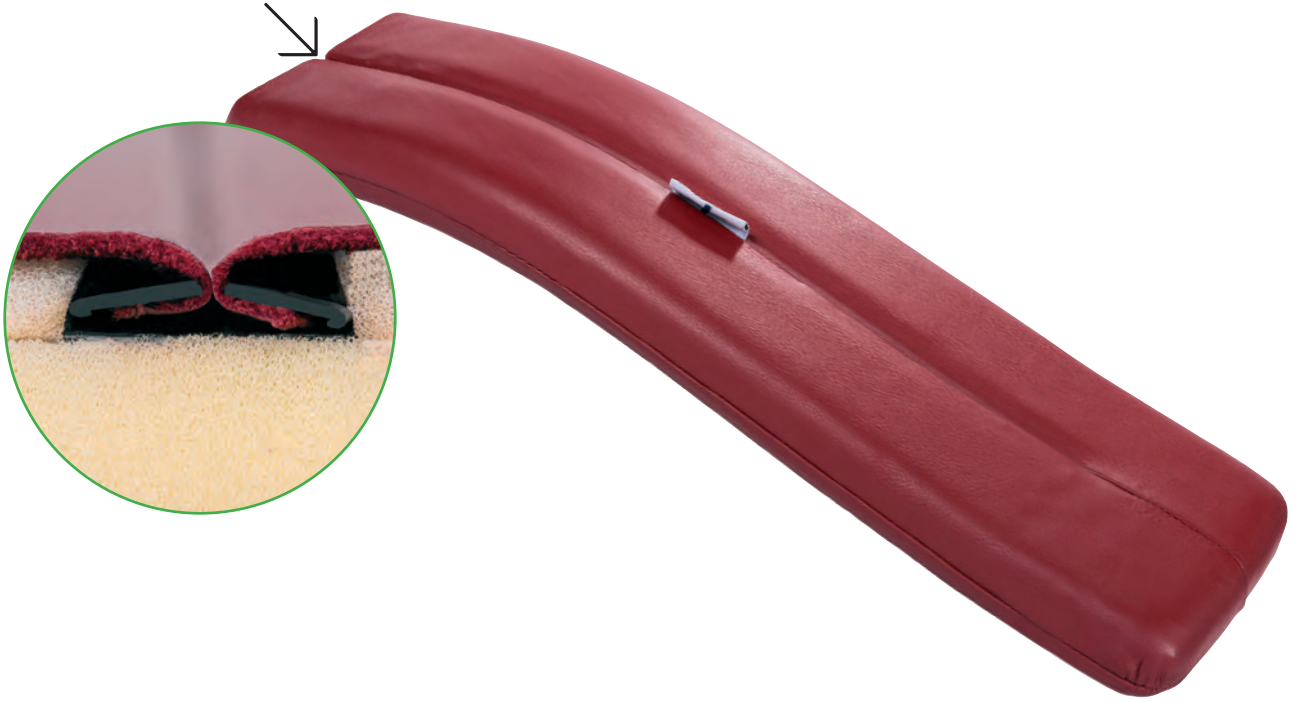
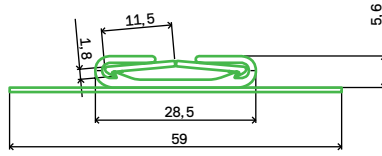

#06 DOPPELVERSCHLUSSSYSTEM/ DOUBLE LOCK SYSTEM

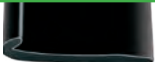
NO.	DESCRIPTION	PU	DIMENSIONS	FLANGE WIDTH
20233-S400	 Verschlussprofil für zwei Stoffbahnen, mit Einschnitten und Vlies lock profile for two fabric panels with cuts and non-woven	50 Stück 50 pcs.	Länge: 1.200 mm length: 1,200 mm	60 mm 60 mm
23115-999	 Gegenleiste counter-bar	Rollen à 500 m rolls at 500 m each	Breite: 11,5 mm width: 11.5 mm	

#07

RÜCKENLEHNE – BACKREST

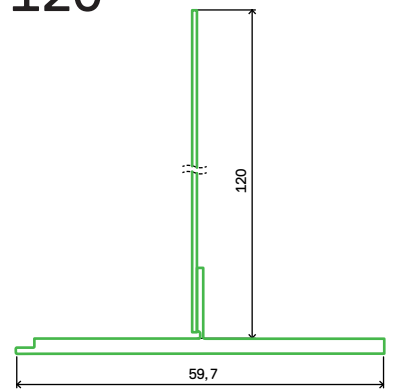

#07 PUNKTABHEFTSTEG/ SINGLE TUFTING STRIP

NO.	DESCRIPTION	PU	DIMENSIONS	FLANGE LENGTH
27860-120	Abheftsteg mit fest verbundenem Vliesstreifen tufting strip with firmly attached non-woven flange	1.000 Stück 1,000 pcs.	Steg: 40 mm strip: 40 mm	120 mm 120 mm

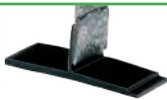

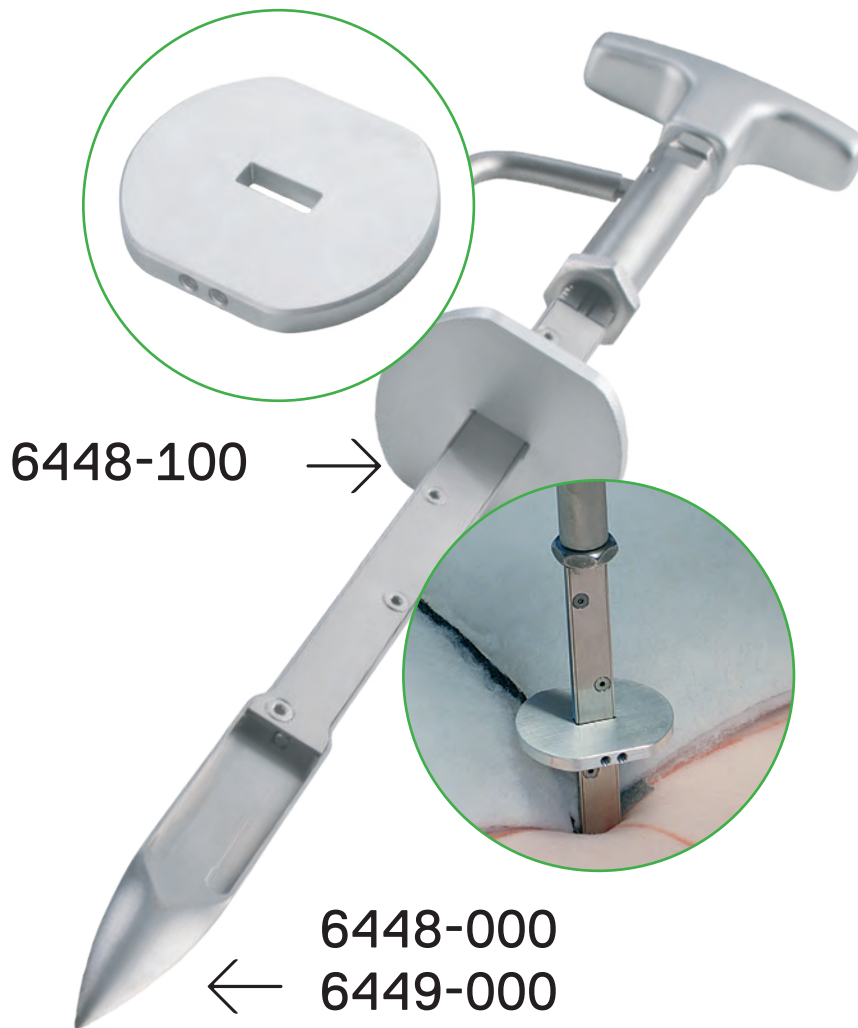

PUNKTABHEFTWERKZEUG/ SINGLE TUFTING TOOL

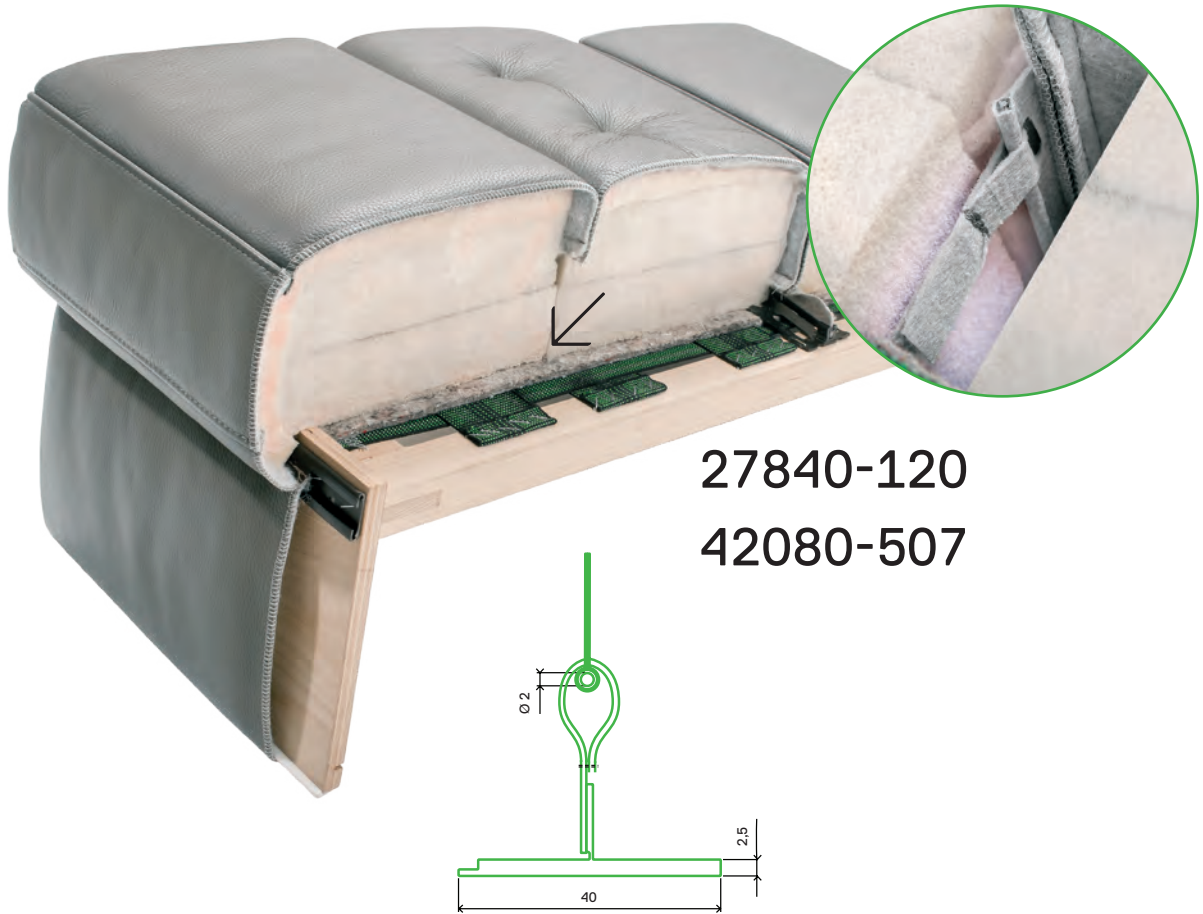

NO.	DESCRIPTION	PU
6448-000 	Stechwerkzeug für Steglänge 40 mm cutting tool for strip length 40 mm	1 Stück 1 pcs.
6449-000 	Stechwerkzeug für Steglänge 60 mm cutting tool for strip length 60 mm	1 Stück 1 pcs.
6448-100 	Tiefenanschlag für Artikel 6448-000 und 6449-000 Depth stop for part no. 6448-000 and 6449-000	1 Stück 1 pcs.



27840-120

42080-507

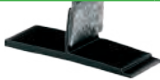
#08 ABHEFTSYSTEM/ TUFTING SYSTEM

NO.	DESCRIPTION	PU	DIMENSIONS	FLANGE LENGTH
27840-120	 Steg mit fest verbundenem Vliesstreifen strip with firmly attached non-woven flange	1.000 Stück 1.000 pcs.	Steg: 40 mm strip: 40 mm	120 mm 120 mm
42080-507	 TieDown mit Drahtkern TieDown with wire core	150 Stück 150 pcs.	2.000 mm 2.000 mm	20 mm 20 mm

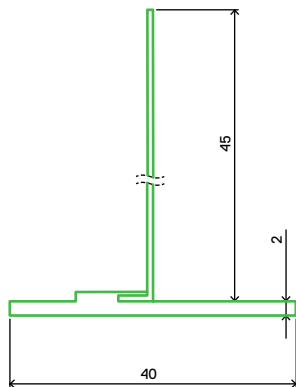

27856-046

4370-034
3694

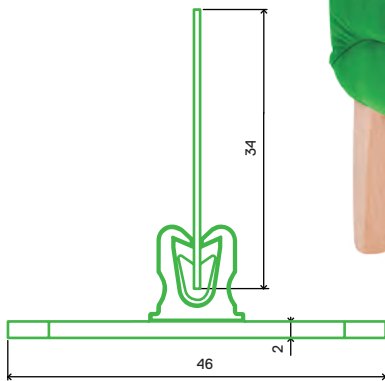

#09 EINZUG-STECKSTREIFEN/ FLUTING STRIP

NO.	DESCRIPTION	PU	DIMENSIONS	FLANGE LENGTH
27856-046	ohne Gegenleiste, einfach querstellen without counter-bar, just set across	75 Stück 75 pcs.	Länge: 1.200 mm length: 1,200 mm	45 mm 45 mm



#10 CLIPFIX-SYSTEM/ CLIPFIX SYSTEM

NO.	DESCRIPTION	PU	DIMENSIONS	FLANGE LENGTH
4370-034	ClipFix extra lang ClipFix extra long	40 Stück 40 pcs.	Länge: 1.200 mm length: 1,200 mm	
3694	TieDown für besonders feste Verbindung TieDown for very fixed connection	auf Anfrage on request	Stab: 5,5 x 6,6 mm rod: 5.5 x 6.6 mm	15-80 mm 15-80 mm

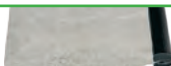



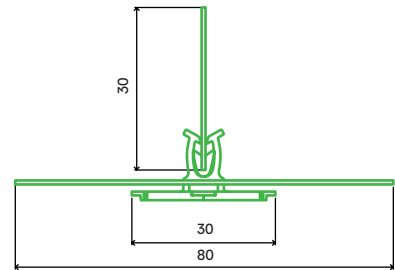

4370-036
3604
5980-0001

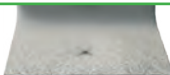

#11 ABHEFTSYSTEM/ TUFTING SYSTEM

NO.	DESCRIPTION	PU	DIMENSIONS	FLANGE LENGTH
4370-036	 Single clip single clip	5.000 Stück 5,000 pcs.	Platte: 30 x 40 mm board: 30 x 40 mm	
3604	 TieDown für besonders schnelle Verarbeitung TieDown for very fast processing	auf Anfrage on request	Stab: 4,5 x 5,4 mm rod: 4.5 x 5.4 mm	15-80 mm 15-80 mm
5980-0001	 Vliesstreifen mit Lochstanzungen non-woven with hole punchings	Rollen à 200 m rolls at 200 m each	Abstand Einschnitte: 80 mm cut distance: 80 mm	80 mm 80 mm

#12 #13

RÜCKENLEHNE – BACKREST

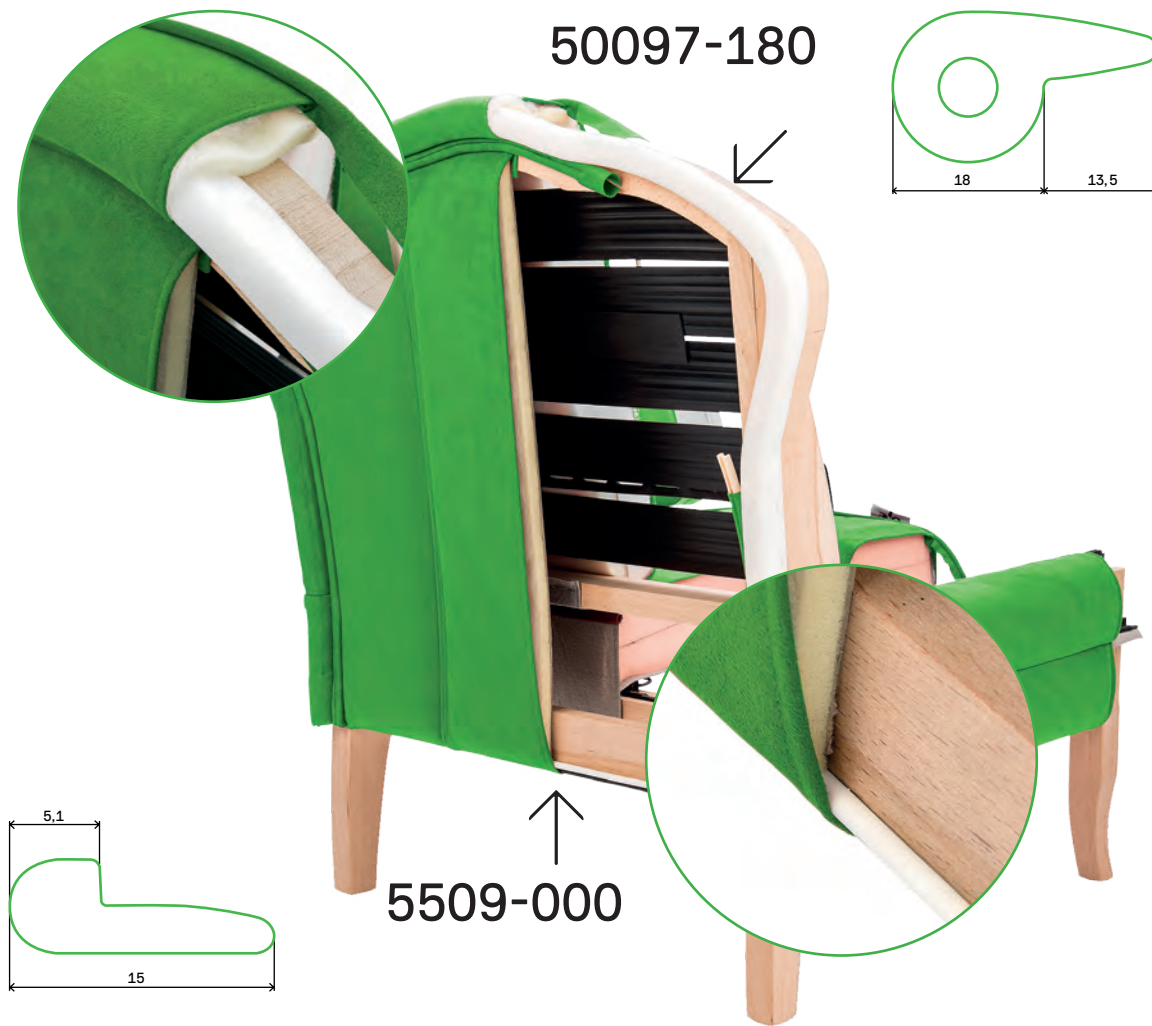

#12 SCHLAUCHKEDER/ EDGE TRIM

NO.	DESCRIPTION	PU	DIMENSIONS
50097-180	breite und runde Geometrie broad and round shape	Rollen à 130 m rolls at 130 m each	Ø 18 mm Ø 18 mm



#13 SCHLAUCHKEDER/ EDGE TRIM

NO.	DESCRIPTION	PU	DIMENSIONS
5509-000	mit dezentem Kantenschutz with unobtrusive edge protection	250 Stück 250 pcs.	Länge: 1.200 mm length: 1,200 mm



14192-300

#14 KLETTVERSCHLUSS UND TIEDOWN/ HOOK AND LOOP AND TIEDOWN

NO.	DESCRIPTION	PU	DIMENSIONS	FLANGE LENGTH
	 Loop for latering Klett zum Einschäumen	50 mtr 50 mtr	Länge: 300 mm length: 300 mm	
14192-300	 EcoTieDown EcoTieDown	50 mtr 50 mtr	Länge: 300 mm length: 300 mm	17,5 mm 17.5 mm

#15

ARMLEHNE – ARMREST

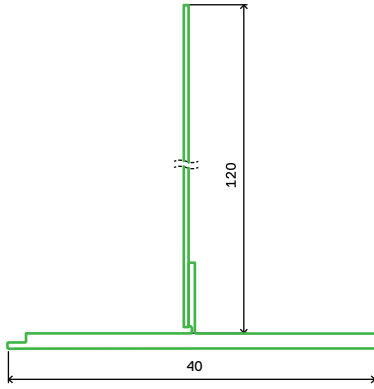

27840-120



#15 PUNKTABHEFTSTEG/ SINGLE TUFTING STRIP

NO.	DESCRIPTION	PU	DIMENSIONS	FLANGE LENGTH
27840-120	Abheftsteg mit fest verbundenem Vliesstreifen tufting strip with firmly attached non-woven flange	1.000 Stück 1,000 pcs.	Steg: 40 mm strip: 40 mm	120 mm 120 mm

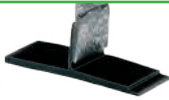



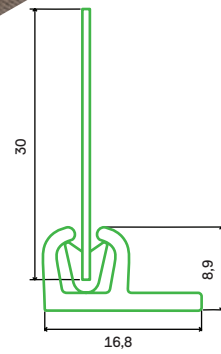

2040-000

2794



#16 LINIEN-ABHEFTSYSTEM/ PLEATLINE TUFTING SYSTEM

NO.	DESCRIPTION	PU	DIMENSIONS	FLANGE LENGTH
2040-000	 Clippfil mit Kunststoffflanze clip profile with plastic flange	100 Stück 100 pcs.	Länge: 1.200 mm length: 1,200 mm	
2794	 TieDown mit Drahtkern TieDown with wire core	auf Anfrage on request	Stab: 4,0 x 5,1 mm rod: 4.0 x 5.1 mm	15-80 mm 15-80 mm

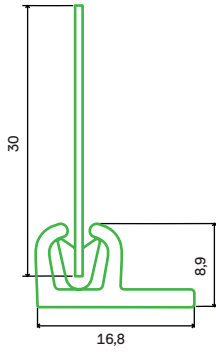

2040-000C
2794

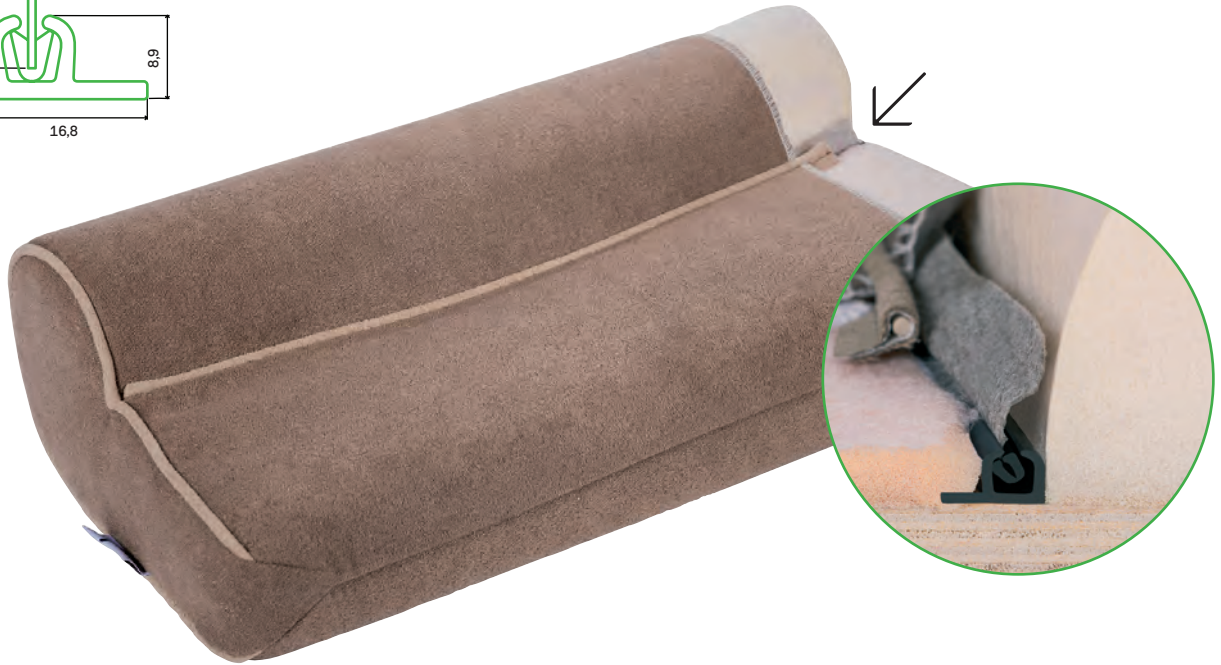

#17 ABHEFTSYSTEM FÜR LEICHTE RADIEN/ TUFTING SYSTEM FOR SLIGHT RADII

NO.	DESCRIPTION	PU	DIMENSIONS	FLANGE LENGTH
2040-000C	 Clippprofil mit Fahne und Einschnitten clip profile with flange and cuts	100 Stück 100 pcs.	Länge: 1.200 mm length: 1,200 mm	
2794	 TieDown für besonders schnelle Verarbeitung TieDown for very fast processing	auf Anfrage on request	Stab: 4,0 x 5,1 mm rod: 4.0 x 5.1 mm	15-80 mm 15-80 mm



#18 VERSCHLUSSSYSTEM/ LOCK SYSTEM

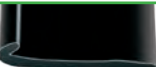

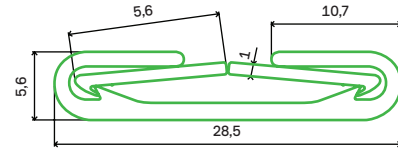
NO.	DESCRIPTION	PU	DIMENSIONS
2271-000	 Verschlussprofil mit Widerhaken lock profile with barb	250 Stück 250 pcs.	Länge: 1.200 mm length: 1,200 mm
23125-999	 Gegenleiste counter-bar	Rollen à 500 m rolls at 500 m each	Breite: 12,5 mm width: 12.5 mm



20232-S000

23125-999

#19 DOPPELVERSCHLUSSSYSTEM/ DOUBLE LOCK SYSTEM

NO.	DESCRIPTION	PU	DIMENSIONS
20232-S000	 <p>Verschlussprofil für zwei Stoffbahnen, ohne Einschnitte lock profile for two fabric panels without cuts</p>	50 Stück 50 pcs.	Länge: 1.200 mm length: 1,200 mm
23125-999	 <p>Gegenleiste counter-bar</p>	Rollen à 500 m rolls at 500 m each	Breite: 12,5 mm width: 12.5 mm

#20



ARMLEHNE – ARMREST

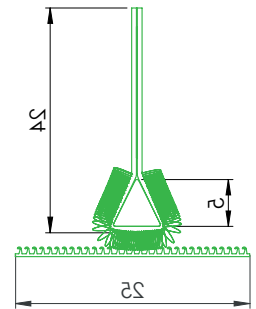

14191-000



#20 KLETTVERSCHLUSS MIT TIEDOWN/ HOOK AND LOOP WITH TIEDOWN

NO.	DESCRIPTION	PU	DIMENSIONS	FLANGE LENGTH
	 Klett zum Tackern Loop for stapling	50 mtr 50 mtr	Breite: 25 mm width: 25 mm	
14191-000	 EcoTieDown EcoTieDown	50 mtr 50 mtr	Stab: 5 x 5 mm rod: 5 x 5 mm	17,5 mm 17,5 mm

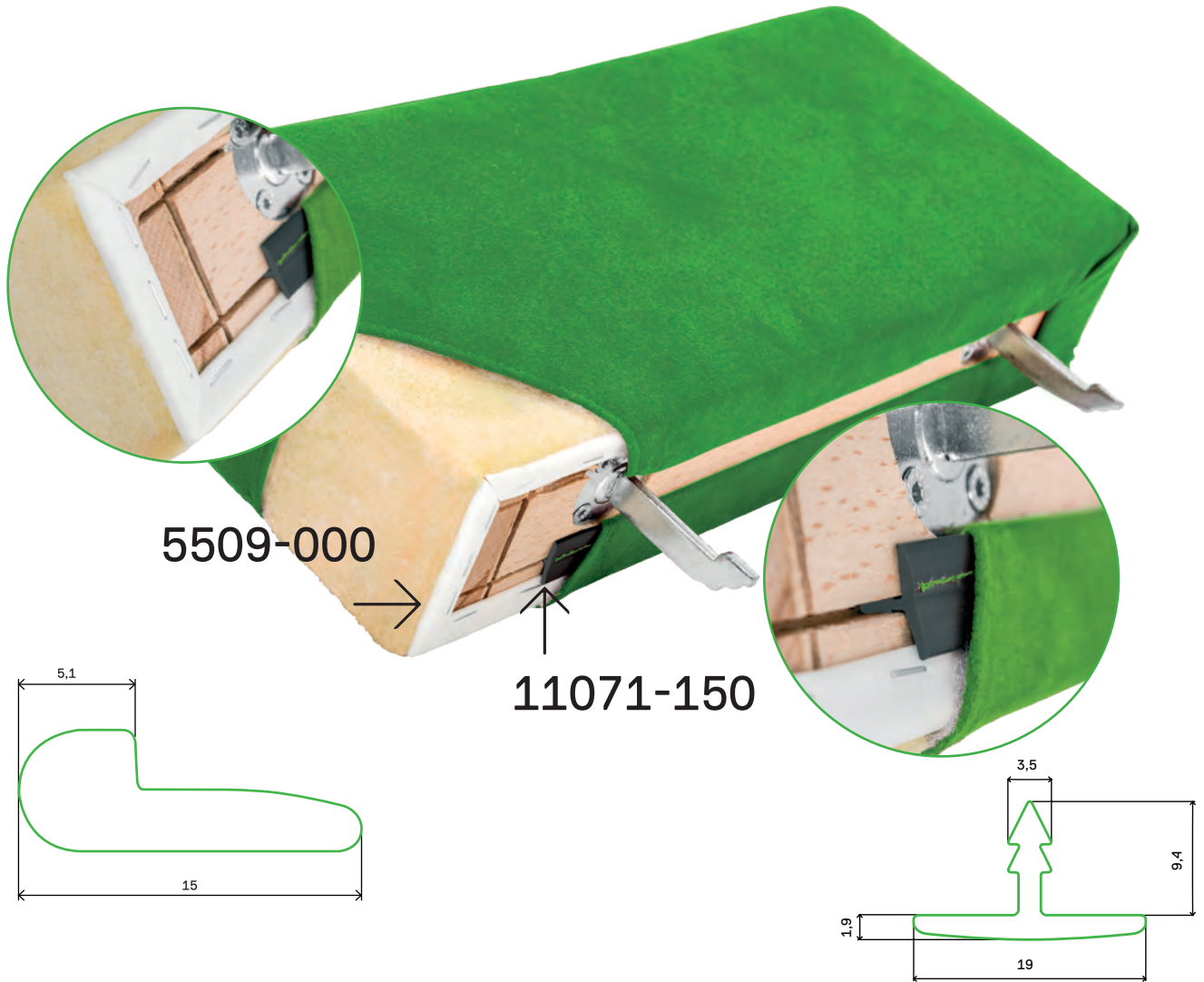

#21 STECKPROFIL/ PLUG-IN PROFILE

NO.	DESCRIPTION	PU	DIMENSIONS
11071-150	mit Oberflächenwölbung with surface curvature	100 Stück 100 pcs.	Länge: 1.500 mm length: 1,500 mm



#22 SCHLAUCHKEDER/ EDGE TRIM

NO.	DESCRIPTION	PU	DIMENSIONS
5509-000	mit dezentem Kantenschutz with unobtrusive edge protection	250 Stück 250 pcs.	Länge: 1.200 mm length: 1,200 mm



#23 #24

ARMLEHNE - ARMREST

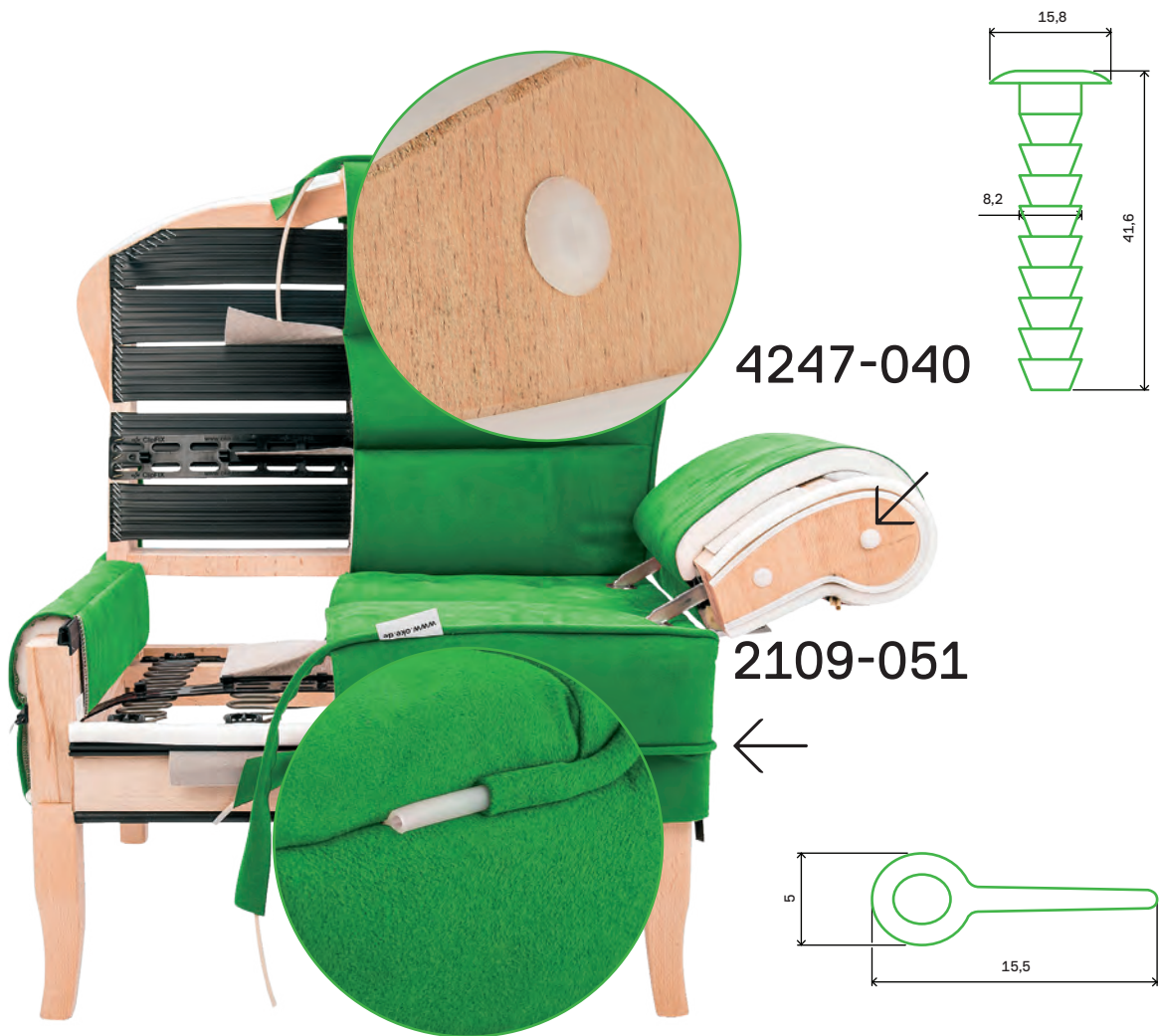

4247-040

2109-051

#23 DÜBEL/ DOWEL

NO.	DESCRIPTION	PU	DIMENSIONS
4247-040	Dübel für Bohrung von Ø 8 mm dowel for hole Ø 8 mm	5.000 Stück 5,000 pcs.	40 mm 40 mm



#24 KEDER MIT KUNSTSTOFFFAHNE/ PIPING WITH PLASTIC FLANGE

NO.	DESCRIPTION	PU	DIMENSIONS
2109-051	für dekorative Kanten und leichte Radien for decorative edges and slight radii	Rollen à 200 m rolls at 200 m each	Abstand Einschnitte: 14 mm cut distance: 14 mm



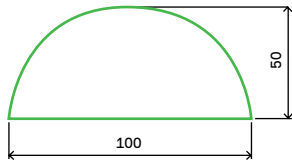

5111-100

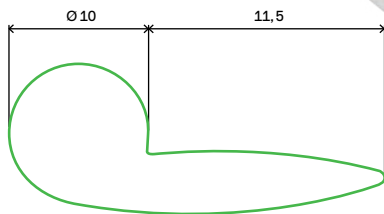
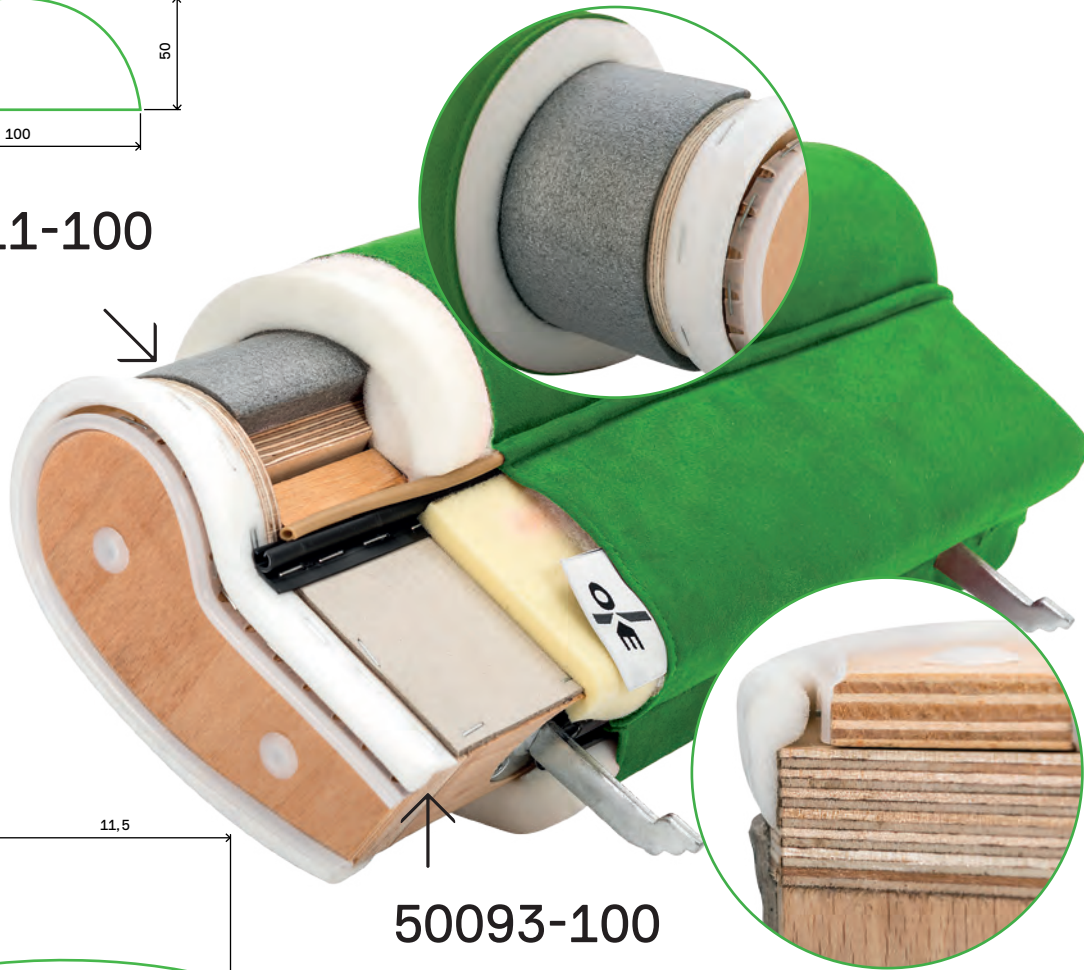

50093-100

#25 SCHLAUCHKEDER/ EDGE TRIM

NO.	DESCRIPTION	PU	DIMENSIONS
50093-100	breite und runde Geometrie broad and round shape	Rollen à 400 m rolls at 400 m each	Ø 10 mm Ø 10 mm



#26 FOAMFLEX LIGHT/ FOAMFLEX LIGHT

NO.	DESCRIPTION	PU	DIMENSIONS
5111-100	extrem weich und leicht, 100 x 50 mm extremely soft and light-weight, 100 x 50 mm	80 m 80 m	Länge: 2.000 mm length: 2.000 mm

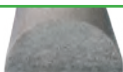

#27

SITZFLÄCHE – SEAT

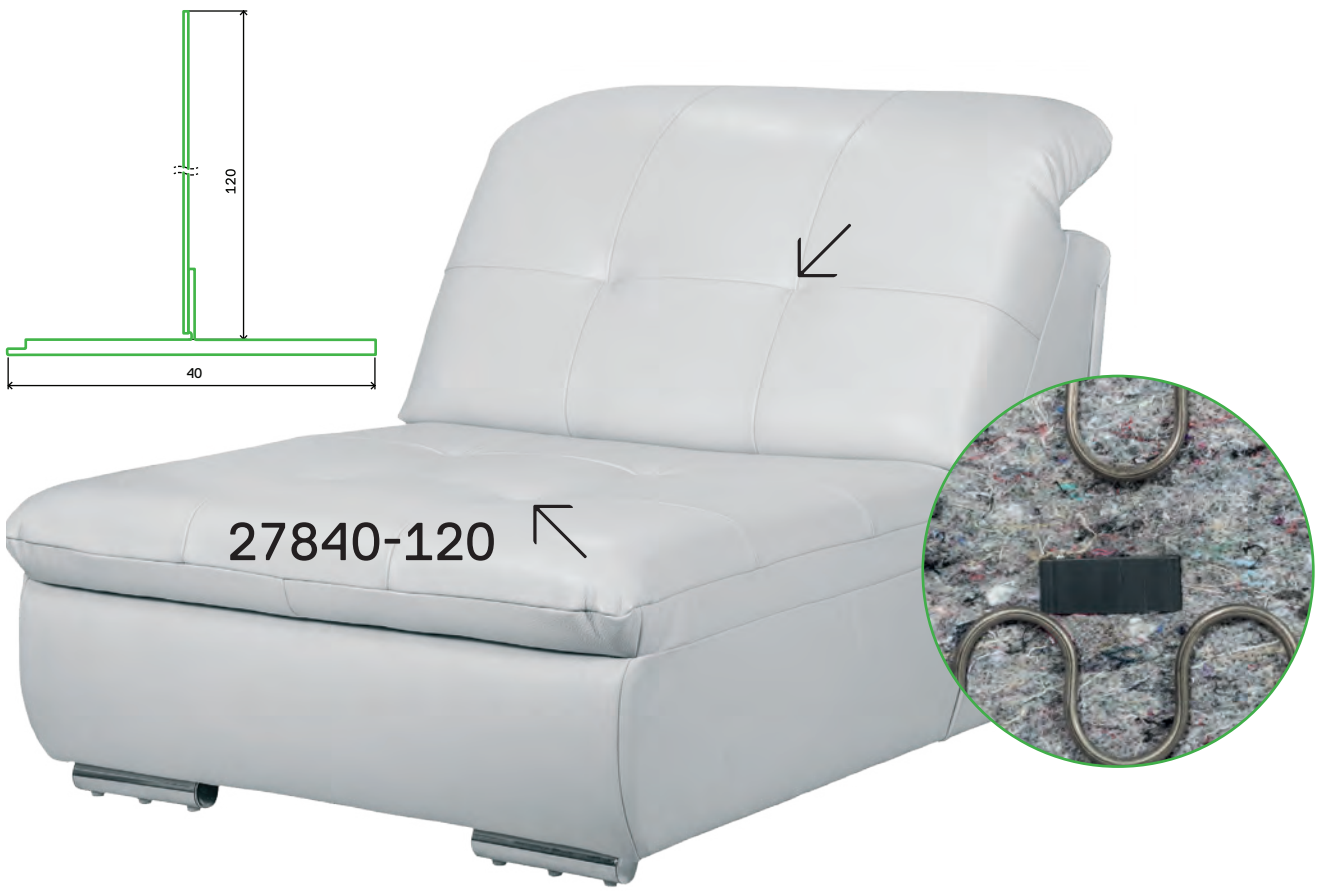

#27 PUNKTABHEFTSTEG/ SINGLE TUFTING STRIP

NO.	DESCRIPTION	PU	DIMENSIONS	FLANGE LENGTH
27840-120	Abheftsteg mit fest verbundenem Vliesstreifen tufting strip with firmly attached non-woven flange	1.000 Stück 1,000 pcs.	Steg: 40 mm strip: 40 mm	120 mm 120 mm

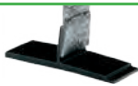

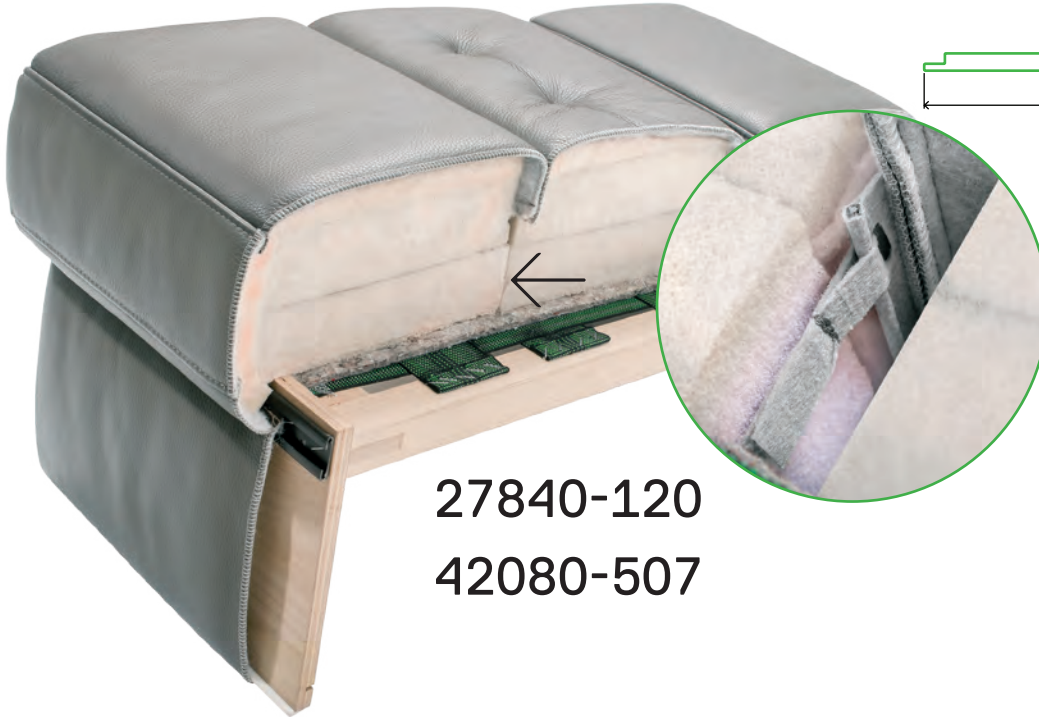

#28

SITZFLÄCHE – SEAT

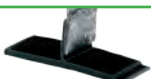

27840-120
42080-507

#28 PUNKTABHEFTSTEG/ SINGLE TUFTING STRIP

NO.	DESCRIPTION	PU	DIMENSIONS	FLANGE LENGTH
27840-120	 Steg mit fest verbundenem Vliesstreifen strip with firmly attached non-woven flange	1.000 Stück 1,000 pcs.	Steg: 40 mm strip: 40 mm	120 mm 120 mm
42080-507	 TieDown mit Drahtkern und Langlöchern TieDown with wire core and long holes	150 Stück 150 pcs.	2.000 mm 2,000 mm	20 mm 20 mm

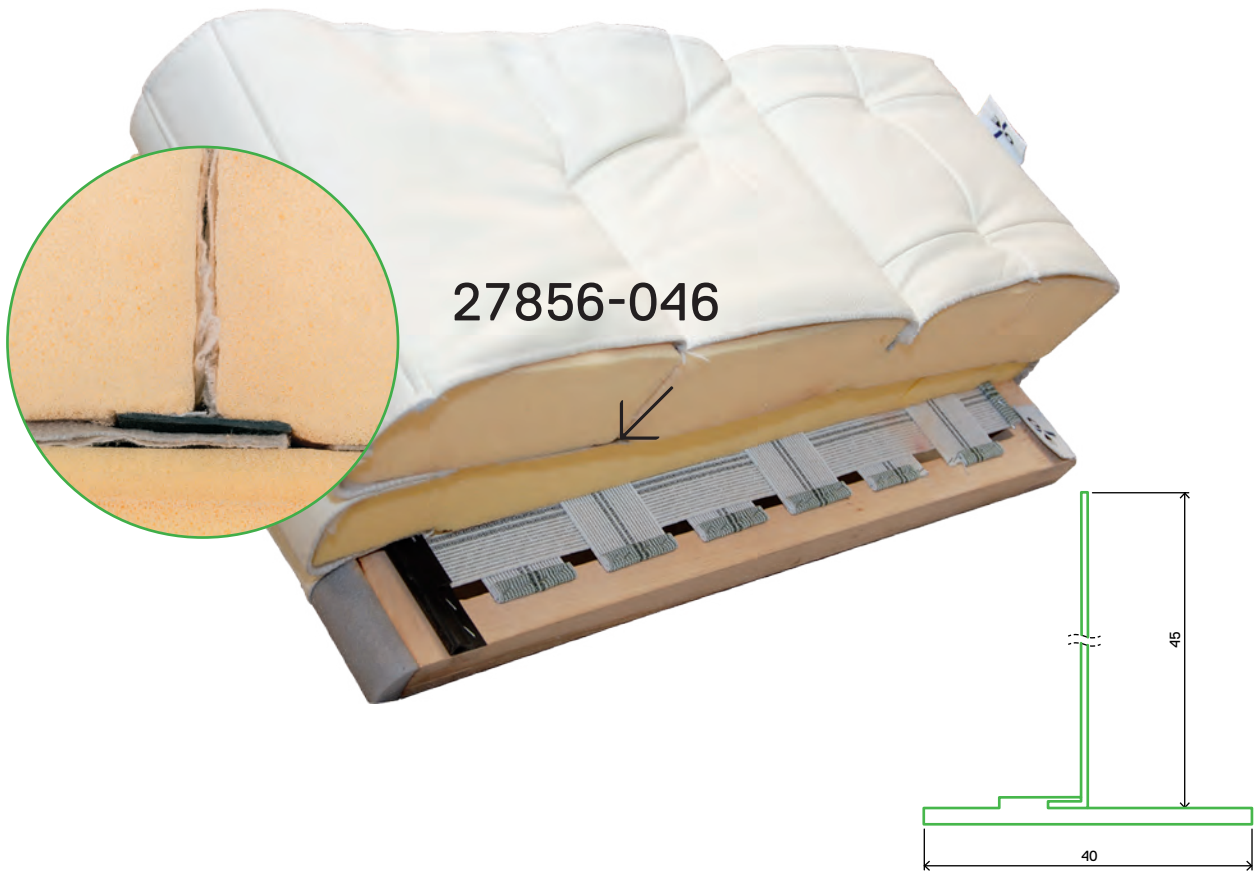

#29 EINZUGSTECKSTREIFEN/ FLUTING STRIP

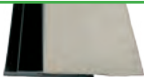
NO.	DESCRIPTION	PU	DIMENSIONS	FLANGE LENGTH
27856-046	 Einzugsteckstreifen ohne Gegenleiste, einfach querstellen fluting strip without counter-bar, just set across	75 Stück	Länge: 1.200 mm	45 mm
		75 pcs.	length: 1.200 mm	45 mm



4370-034

3694

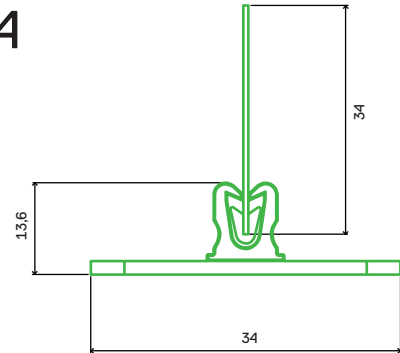

#30 CLIPFIX-SYSTEM/ CLIPFIX SYSTEM

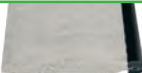

NO.	DESCRIPTION	PU	DIMENSIONS	FLANGE LENGTH
4370-034	 ClipFix extra lang ClipFix extra long	40 Stück 40 pcs.	Länge: 1.200 mm length: 1,200 mm	
3694	 TieDown für besonders feste Verbindung TieDown for very fixed connection	auf Anfrage on request	Stab: 5,5 x 6,6 mm rod: 5.5 x 6.6 mm	15-80 mm 15-80 mm

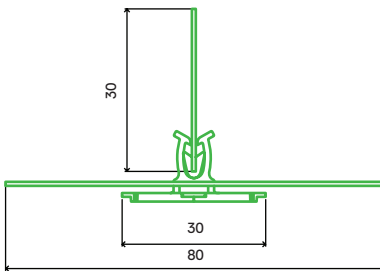

↙
4370-036
3604
5980-0001

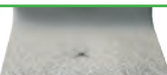

#31 SINGLE CLIP SYSTEM/ SINGLE CLIP SYSTEM

NO.	DESCRIPTION	PU	DIMENSIONS	FLANGE LENGTH
4370-036	 Single clip single clip	5.000 Stück 5,000 pcs.	Platte: 30 x 40 mm board: 30 x 40 mm	
3604	 TieDown für besonders schnelle Verarbeitung TieDown for very fast processing	auf Anfrage on request	Stab: 4,5 x 5,4 mm rod: 4.5 x 5.4 mm	15-80 mm 15-80 mm
5980-0001	 Vliesstreifen mit Lochstanzungen non-woven with hole punchings	Rollen à 200 m rolls at 200 m each	Abstand Einschnitte: 80 mm cut distance: 80 mm	80 mm 80 mm

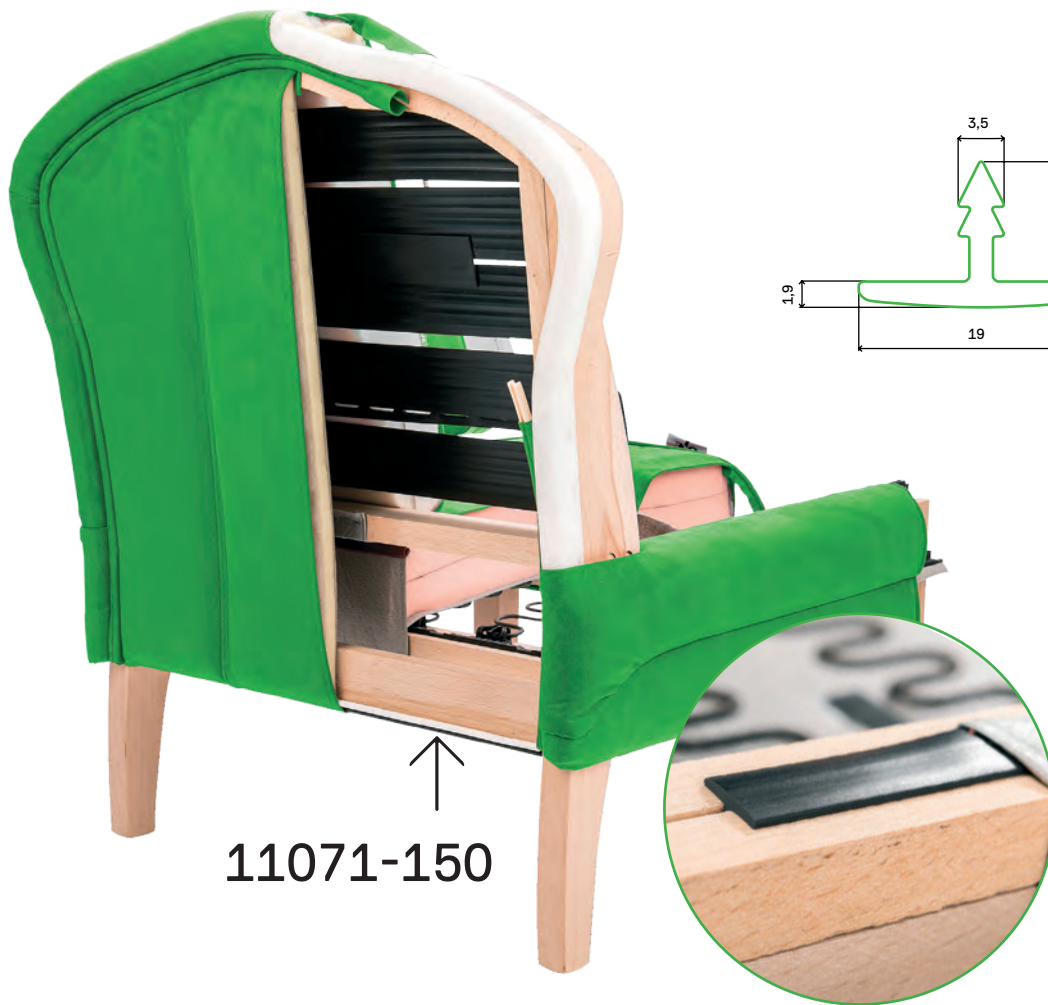

11071-150

#32 STECKPROFIL/ PLUG-IN PROFILE

NO.	DESCRIPTION	PU	DIMENSIONS
11071-150	mit Oberflächenwölbung with surface curvature	100 Stück 100 pcs.	Länge: 1.500 mm length: 1,500 mm

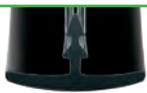



#33 KLEMMPROFIL/ FASTENING PROFILE

NO.	DESCRIPTION	PU	DIMENSIONS	FLANGE LENGTH
2700-000	mit Vliesfahne, für Blechstärken 1,5 - 2,5 mm with non-woven flange, for metal sheets 1.5 - 2.5 mm	75 Stück 75 pcs.	Länge: 1.200 mm length: 1,200 mm	10 mm 10 mm



↑
2709-004

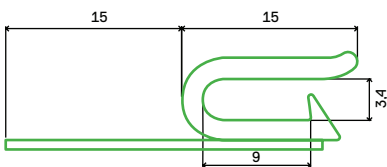

#34 HAKENPROFIL/ HOOK PROFILE

NO.	DESCRIPTION	PU	DIMENSIONS	FLANGE LENGTH
2709-004	 mit Vliesfahne with non-woven flange	100 Stück 100 pcs.	Länge: 1.200 mm length: 1.200 mm	15 mm 15 mm

#35

SITZFLÄCHE – SEAT

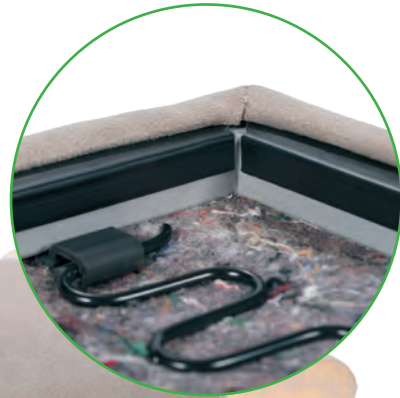
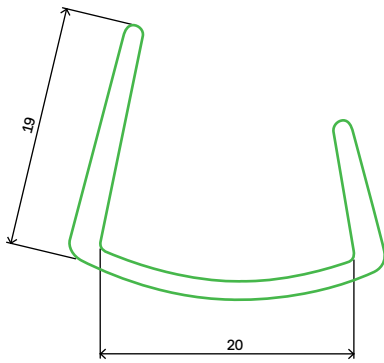

1003-000

#35 U-PROFIL/ U-PROFILE

NO.	DESCRIPTION	PU	DIMENSIONS
1003-000	zum Anclipsen von Stoffen for clipping on fabrics	40 Stück 40 pcs.	1.000 mm 1.000 mm





50097-180

#36 SCHLAUCHKEDER/ EDGE TRIM

NO.	DESCRIPTION	PU	DIMENSIONS
50097-180	breite und runde Geometrie broad and round shape	Rollen à 130 m rolls at 130 m each	Ø 18 mm Ø 18 mm





0172-142

#37 QUERELASTISCHER TIEDOWN/ TRANSVERSELY ELASTIC TIEDOWN

NO.	DESCRIPTION	PU	DIMENSIONS	FLANGE LENGTH
0172-142	Vlies ist querelastisch dehnbar. Vlies is stretchable.	auf Anfrage on request	Länge: 1.200 mm Length: 1,200 mm	15 - 100 mm 15 - 100 mm

27910-000

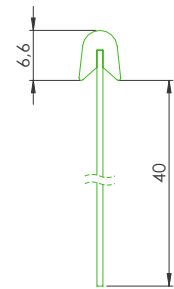
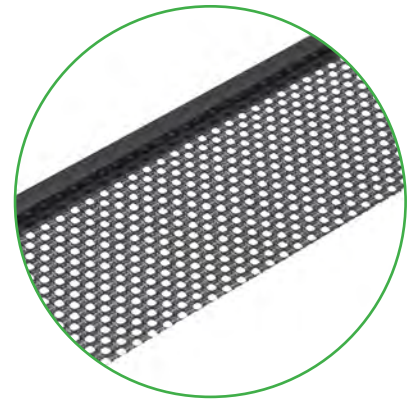

#38 AIRTIEDOWN/ AIRTIEDOWN

NO.	DESCRIPTION	PU	DIMENSIONS	FLANGE LENGTH
27910-000	für eine bessere Luftzirkulation in Klimasitze for better air circulation in climate seats	auf Anfrage on request	Länge: 1.200 mm Length: 1,200 mm	15 - 80 mm 15 - 80 mm



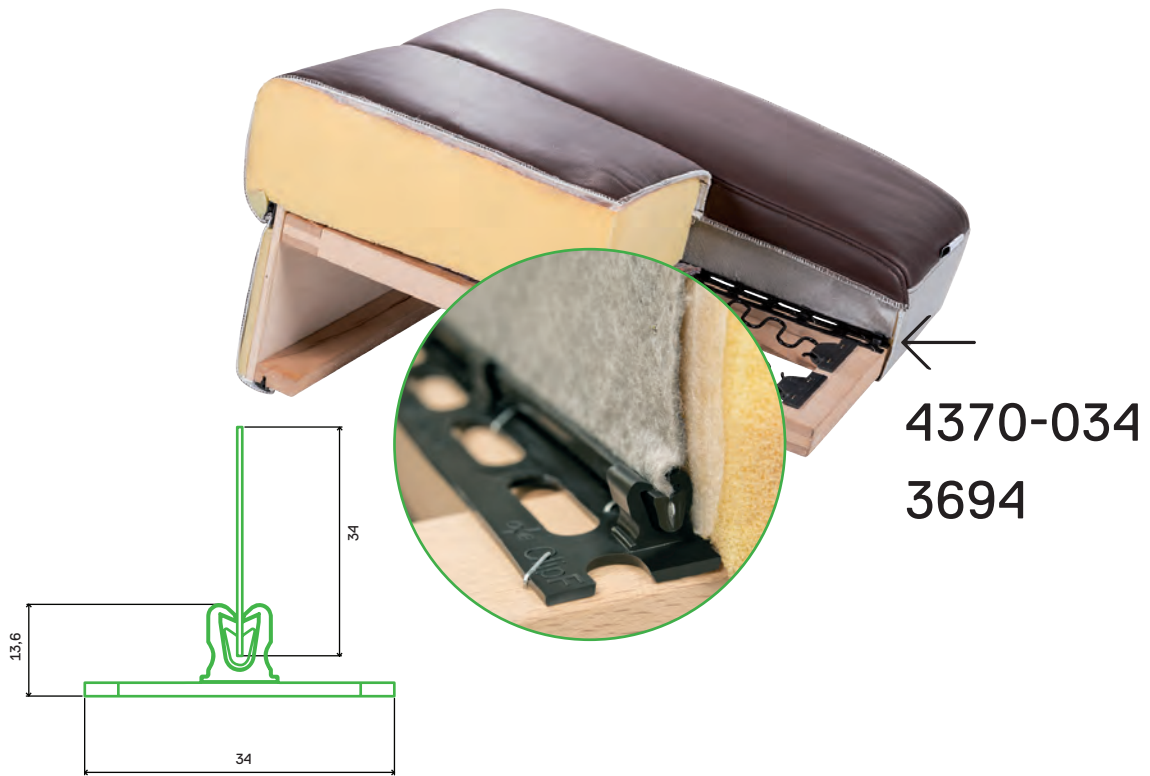

4370-034
3694

#39 CLIPFIX-SYSTEM/ CLIPFIX SYSTEM

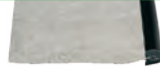
NO.	DESCRIPTION	PU	DIMENSIONS	FLANGE LENGTH
4370-034	 <p>ClipFix extra lang ClipFix extra long</p>	40 Stück 40 pcs.	Länge: 1.200 mm length: 1,200 mm	
3694	 <p>TieDown für besonders feste Verbindung TieDown for very fixed connection</p>	auf Anfrage on request	Stab: 5,5 x 6,6 mm rod: 5.5 x 6.6 mm	15-80 mm 15-80 mm

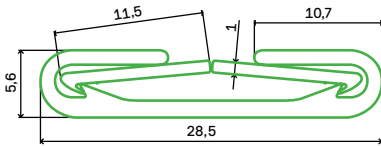

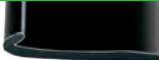

←
20232-S000
23115-999

#40 DOPPELVERSCHLUSSSYSTEM/ DOUBLE LOCK SYSTEM

NO.	DESCRIPTION	PU	DIMENSIONS
20232-S000	 Profil für zwei Stoffbahnen, ohne Einschnitte profile for two fabric panels without cuts	50 Stück 50 pcs.	Länge: 1.200 mm length: 1,200 mm
23115-999	 Gegenprofil counter-bar	Rollen à 500 m rolls at 500 m each	Breite: 11,5 mm width: 11.5 mm



#41 VERSCHLUSSSYSTEM/ LOCK SYSTEM

NO.	DESCRIPTION	PU	DIMENSIONS
2298-000	 Verschlussprofil mit Widerhaken lock profile with barb	150 Stück 150 pcs.	Länge: 1.200 mm length: 1,200 mm
2297-000	 Gegenleiste mit Kugel counter-bar with ball	300 Stück 300 pcs.	Länge: 1.200 mm length: 1,200 mm

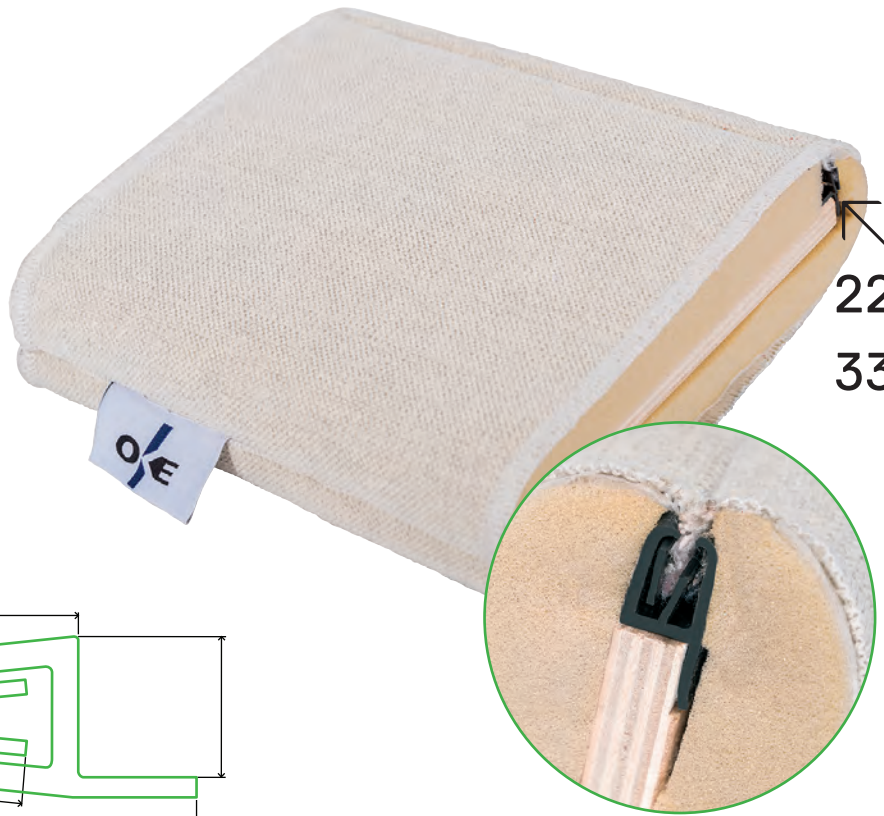

2288-000

33009-10999

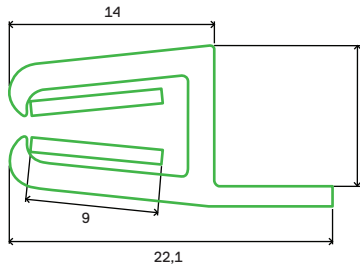

#42 KANTENVERSCHLUSSSYSTEM/ EDGE LOCK SYSTEM

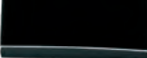
NO.	DESCRIPTION	PU	DIMENSIONS
2288-000	 Profil mit Kunststoffflanke zum Tackern profile with plastic flange for stapling	100 Stück 100 pcs.	Länge: 1.200 mm length: 1.200 mm
33009-10999	 Gegenleiste counter-bar	Rollen à 1.500 m roll at 1.500 m each	1 x 9 mm 1 x 9 mm

#43

GESTELL - FRAME

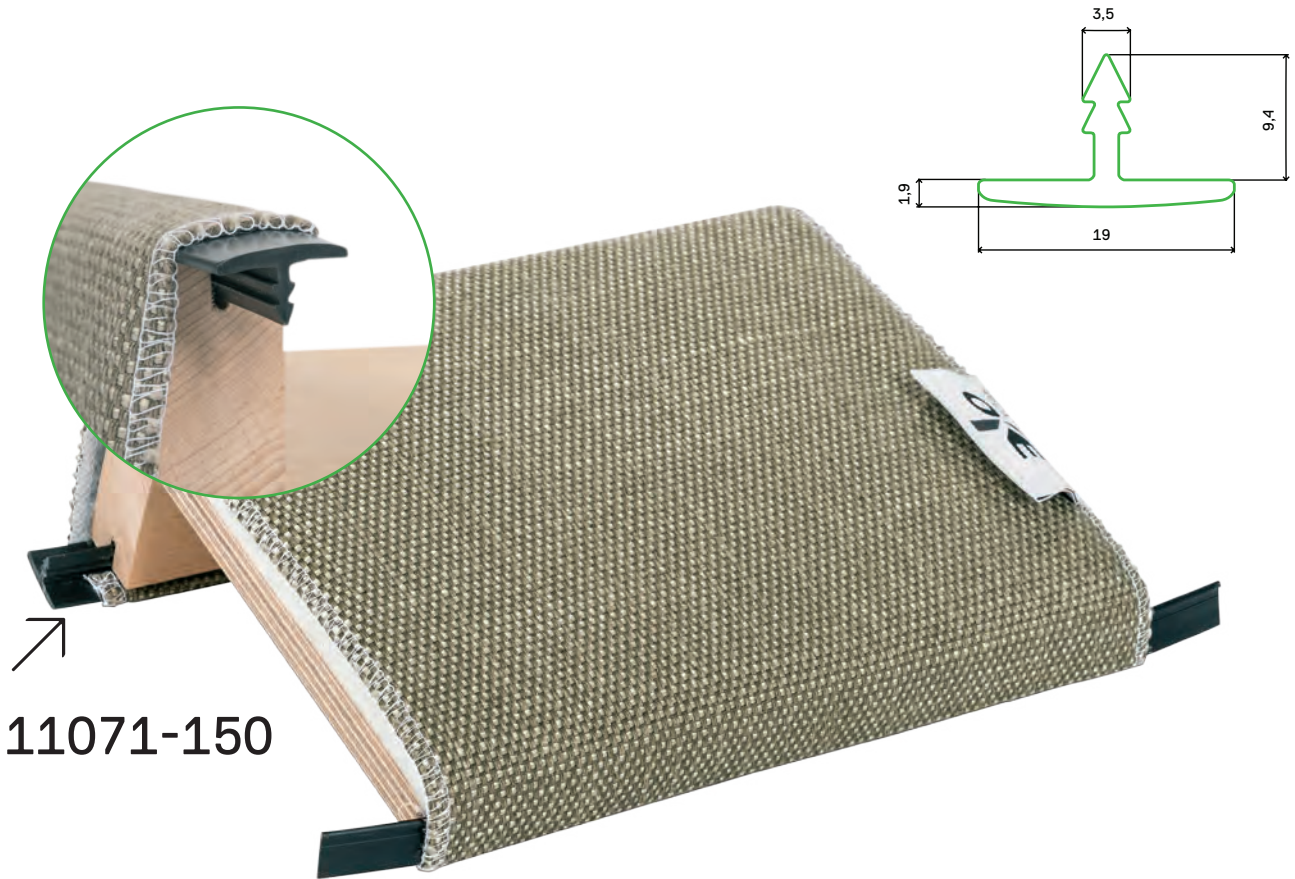

#43 STECKPROFIL/ PLUG-IN PROFILE

NO.	DESCRIPTION	PU	DIMENSIONS
11071-150	mit Oberflächenwölbung with surface curvature	100 Stück 100 pcs.	Länge: 1.500 mm length: 1,500 mm



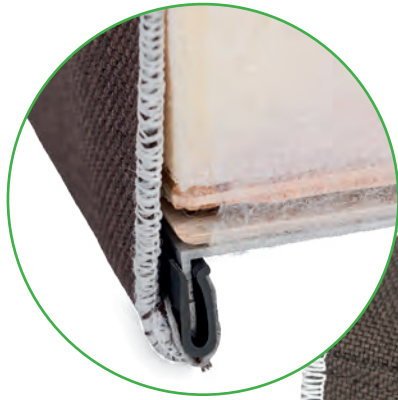

2700-000

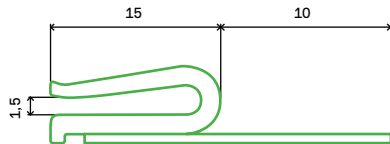

#44 KLEMMPROFIL/ FASTENING PROFILE

NO.	DESCRIPTION	PU	DIMENSIONS	FLANGE LENGTH
2700-000	mit Vliesfahne, für Blechstärken 1,5 - 2,5 mm with non-woven flange, for metal sheets 1.5 - 2.5 mm	75 Stück 75 pcs.	Länge: 1.200 mm length: 1,200 mm	10 mm 10 mm





↙
2709-004

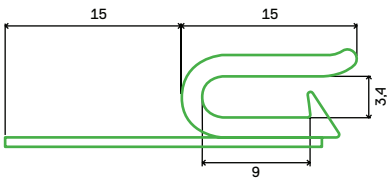

#45 HAKENPROFIL/ HOOK PROFIL

NO.	DESCRIPTION	PU	DIMENSIONS	FLANGE LENGTH
2709-004	mit Vliesfahne with non-woven flange	100 Stück 100 pcs.	Länge: 1.200 mm length: 1,200 mm	15 mm 15 mm

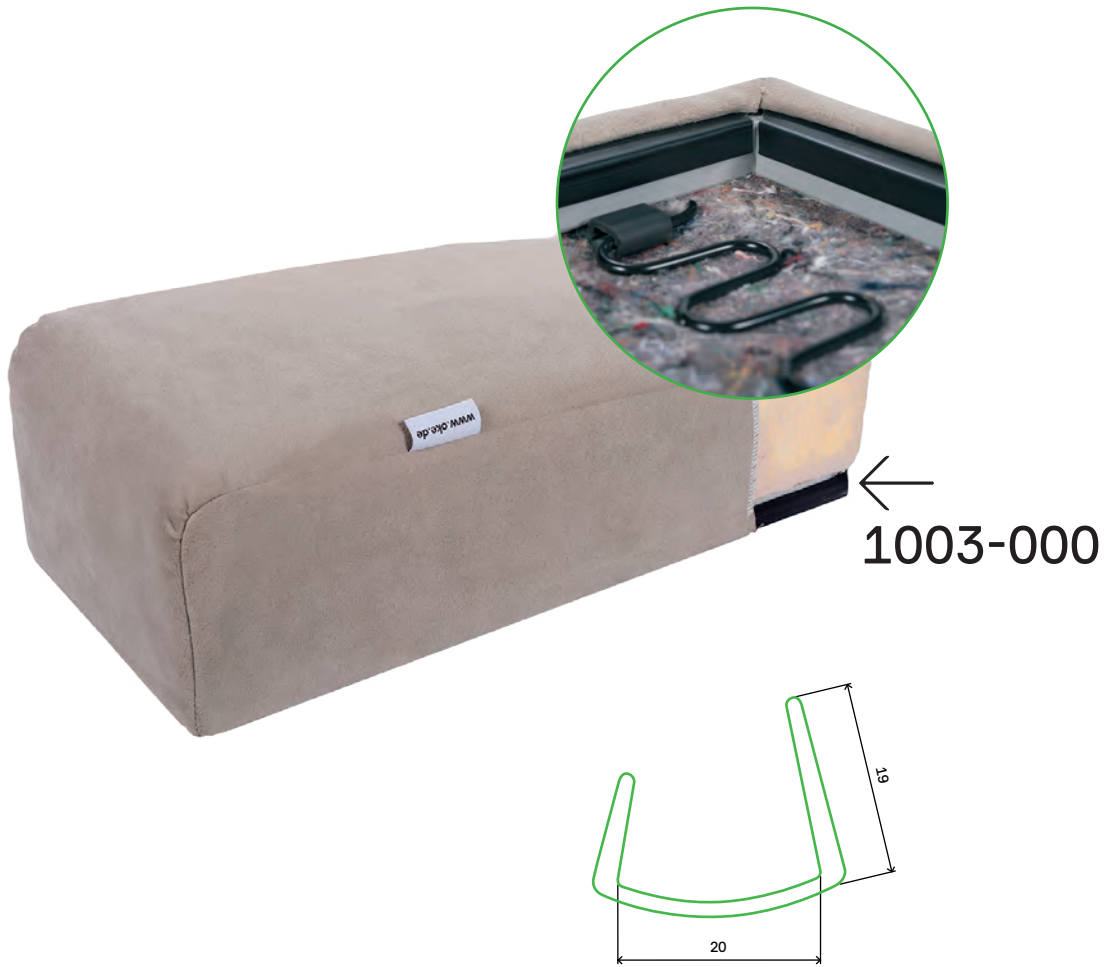

#46 U-PROFIL/
U-PROFILE

NO.	DESCRIPTION	PU	DIMENSIONS
1003-000	zum Anclipsen von Stoffen for clipping on fabrics	40 Stück 40 pcs.	Länge: 1.000 mm length: 1,000 mm

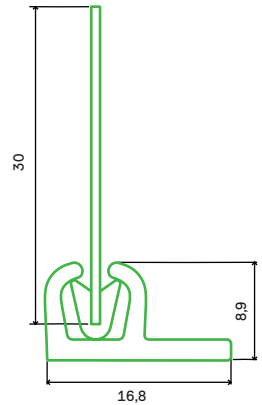

#47 LINIEN-ABHEFTSYSTEM/ PLEATLINE TUFTING SYSTEM

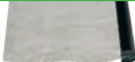
NO.	DESCRIPTION	PU	DIMENSIONS	FLANGE LENGTH
2040-000	 Führungsschiene mit Kunststoffflanke guide rail with plastic flange	100 Stück 100 pcs.	Länge: 1.200 mm length: 1,200 mm	
2794	 TieDown für besonders schnelle Verarbeitung TieDown for very fast processing	auf Anfrage on request	Stab: 4,0 x 5,1 mm rod: 4.0 x 5.1 mm	15-80 mm 15-80 mm

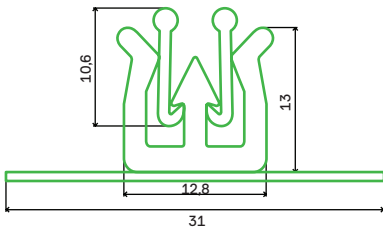

3012-000

2371-000

#48 DOPPELVERSCHLUSSSYSTEM/ DOUBLE LOCK SYSTEM

NO.	DESCRIPTION	PU	DIMENSIONS	FLANGE LENGTH
3012-000	mit Vlies zum Einschäumen with non-woven for foaming	75 Stück 75 pcs.	Clipbreite: 14 mm clip width: 14 mm	30 mm 30 mm
2371-000	Gegenleiste counter-bar	500 Stück 500 pcs.	Breite: 10,6 mm width: 10.6 mm	

#49

GESTELL – FRAME



50097-180

#49 BOURLÉ/ EDGE TRIM

NO.	DESCRIPTION	PU	DIMENSIONS
50097-180	breite und runde Geometrie broad and round shape	Rollen à 130 m rolls at 130 m each	Ø 18 mm Ø 18 mm

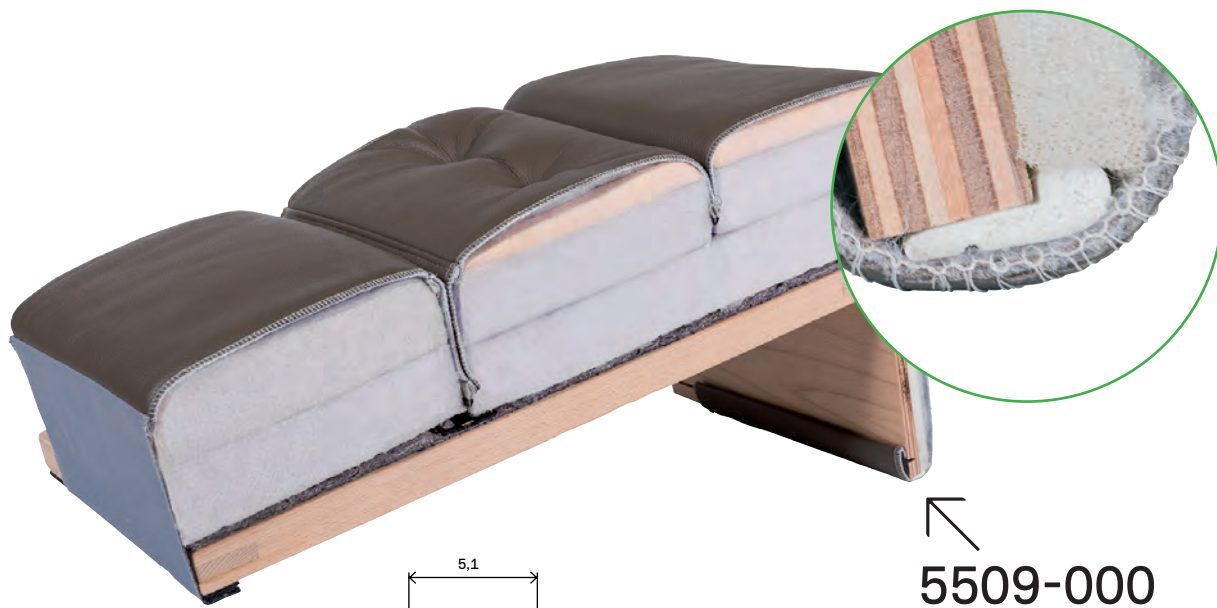

#50 BOURLÉ/ EDGE TRIM

NO.	DESCRIPTION	PU	DIMENSIONS
5509-000	mit dezentem Kantenschutz with unobstrusive edge protection	250 Stück 250 pcs.	Länge: 1.200 mm length: 1,200 mm

#51

GESTELL – FRAME

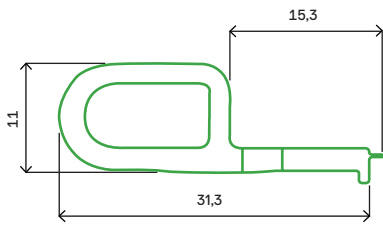

4900-100



#51 CLIP STRIP PLUS/ CLIP STRIP PLUS

NO.	DESCRIPTION	PU	DIMENSIONS
4900-100	 zur Befestigung von Wellenfedern im und auf dem Rahmen for zigzag spring attachment in and on the frame	2.200 Stück 2,200 pcs.	Clipabstand: 100 mm clip distance: 100 mm

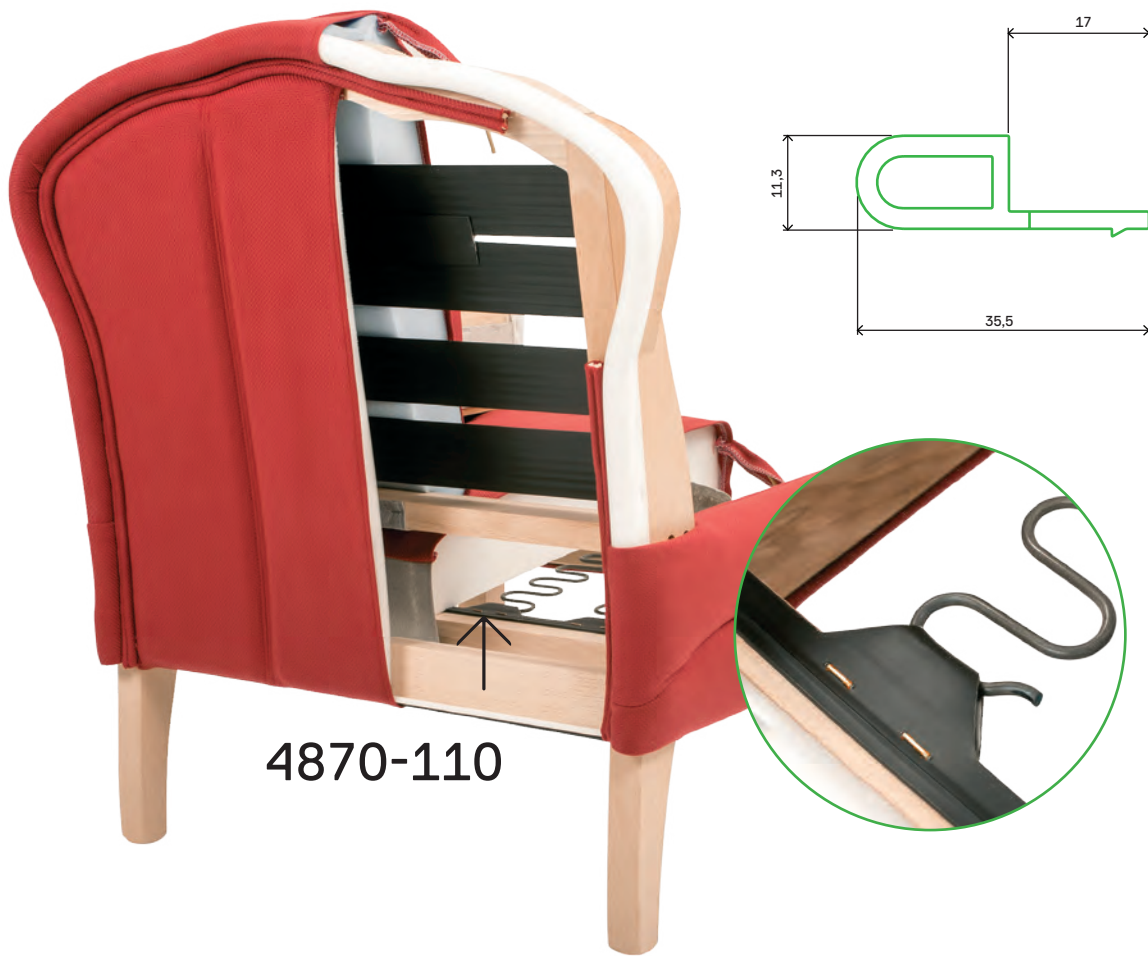

4870-110

#52 SCHARNIERLEISTE/ CLIP STRIP

NO.	DESCRIPTION	PU	DIMENSIONS
4870-110	zur Befestigung von Wellenfedern im Rahmen for zigzag spring attachment in the frame	1.300 Stück 1,300 pcs.	Clipabstand: 110 mm clip distance: 110 mm



#53

GESTELL – FRAME

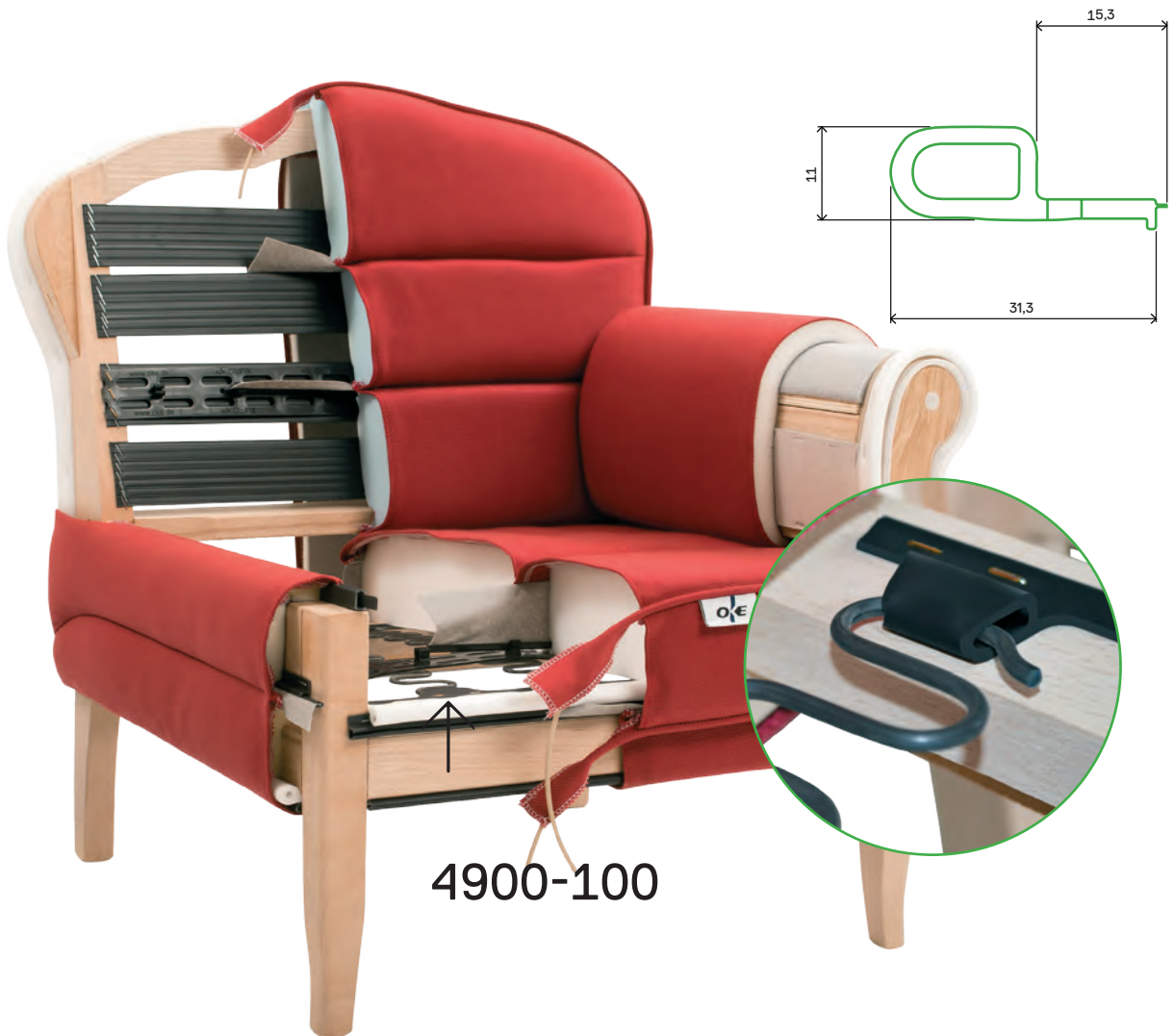

4900-100

#53 CLIP STRIP PLUS/ CLIP STRIP PLUS

NO.	DESCRIPTION	PU	DIMENSIONS
4900-100	zur Befestigung von Wellendern im und auf Rahmen for zigzag spring attachment in and on the frame	2.000 Stück 2,000 pcs.	Clipabstand: 110 mm clip distance: 110 mm



4001-020

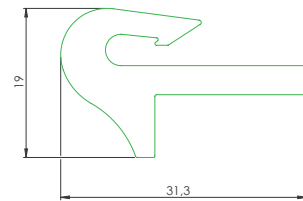
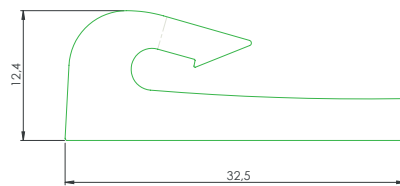

#54 EINZELCLIP/ SINGLE CLIP

NO.	DESCRIPTION	PU	DIMENSIONS
4001-020	zur Befestigung von Wellenfedern auf Holzrahmen for zigzag spring attachment on wooden frames	5.000 Stück 5,000 pcs.	Länge: 20 mm length: 20 mm
17202	zur Befestigung von Wellenfedern im Rahmen for zigzag spring attachment in the frame	auf Anfrage on request.	20 x 31,3 x 19,0 mm 20 x 31.3 x 19.0 mm
1207	zur Befestigung von Wellenfedern auf Rahmen for zigzag spring attachment on the frame	auf Anfrage on request.	20 x 32,5 x 12,4 mm 20 x 32.5 x 12.4 mm



4872-020

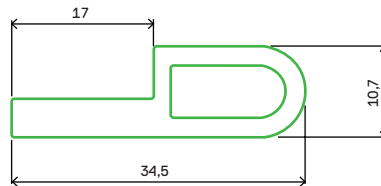

#55 EINZELCLIP/ SINGLE CLIP

NO.	DESCRIPTION	PU	DIMENSIONS
4872-020	zur Befestigung von Wellenfedern in Holz- und Metallrahmen for zigzag spring attachment in wooden and metal frames	4.000 Stück 4,000 pcs.	Länge: 20 mm length: 20 mm



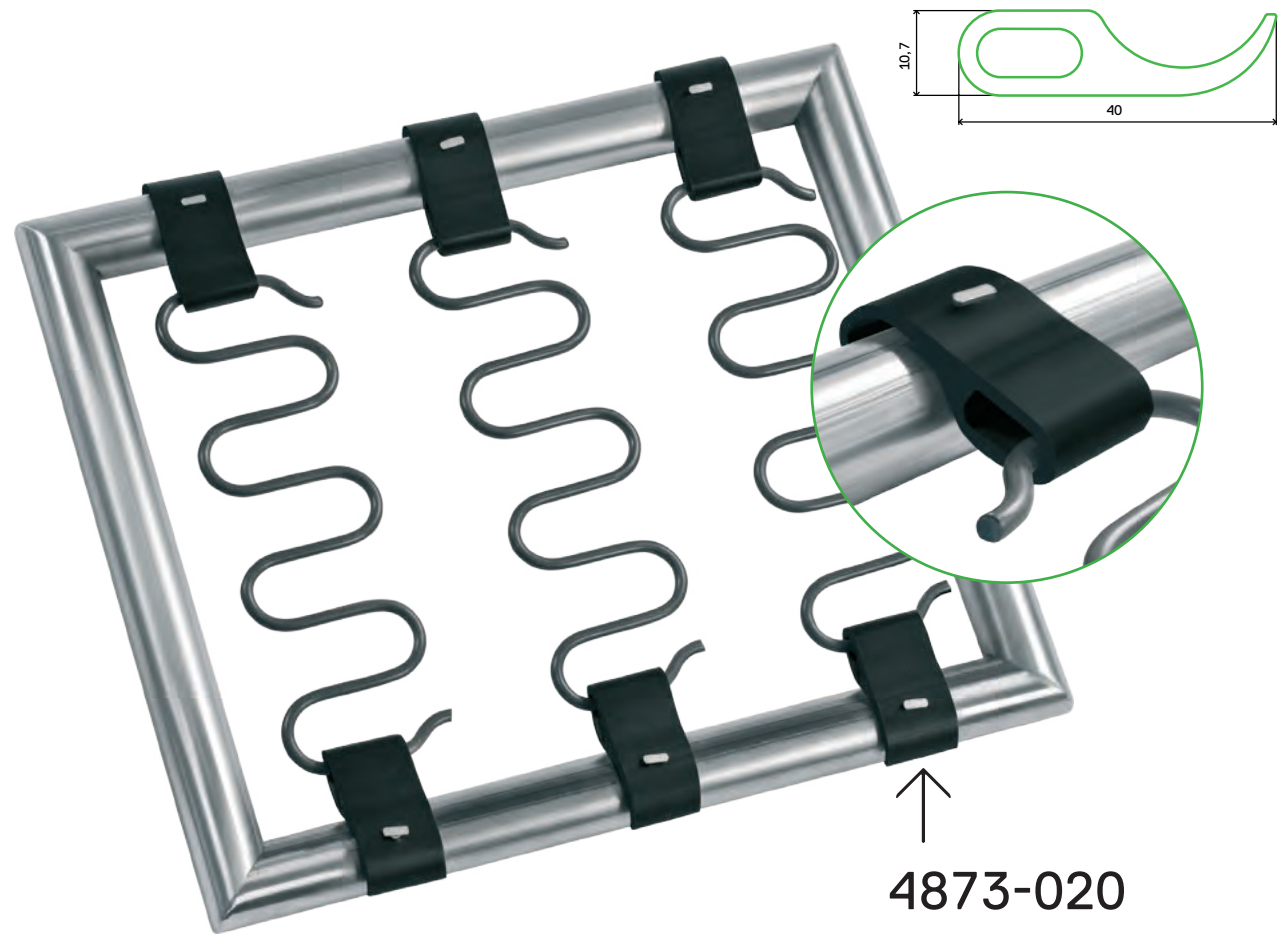

#56 EINZELCLIP/
SINGLE CLIP

NO.	DESCRIPTION	PU	DIMENSIONS
4873-020	zur Befestigung von Wellenfedern auf Rundrohr-Rahmen, Ø 18 mm for zigzag spring attachment on tubular frames, Ø 18 mm	4.000 Stück 4,000 pcs.	Länge: 20 mm length: 20 mm





OBJEKTMÖBEL

Hoher Sitzkomfort bei dünnen Schäumen: ClipFix macht's möglich. Ergänzend dazu gibt es unsere filigranen und besonders stabilen Einzugstäbe.

CONTRACT FURNITURE

High seating comfort for thin foam: ClipFix does it. And complementary with it, our filigree and particularly stable TieDowns.

OBJEKT- MÖBEL/ CONTRACT FURNITURE

Möbel für den Privatbereich werden schonender genutzt als Objektmöbel, die der Öffentlichkeit zugänglich sind. Die Beanspruchung ist intensiver und oft ‚ruppiger‘, zugleich sollen die Möbel über die Funktion hinaus Wertigkeit repräsentieren. Wir kennen die besonderen Anforderungen an Objektmöbel und finden für unsere Kunden Lösungen, die besonders robust, pflegeleicht und auch in geringerer Stückzahl wirtschaftlich sind. Wir kümmern uns um strapazierfähige Ecken und Kanten, abnehmbare Stoffbezüge und intelligente, kundenspezifische Designs.

Furniture for the private sector is used with greater care than contract furniture, which is available to the public. The strain is more intense and often “rougher”. At the same time, beyond its functionality the furniture should represent an enhanced value. We are familiar with the special requirements for contract furniture and find solutions for our customers which are particularly robust, easy-care and still economical, even in smaller quantities. We ensure that there are heavy-duty edges and corners, removable fabric covers and intelligent, customer-specific designs.

62 → #57 – #65

RÜCKENLEHNE/
GESTELL
BACKREST/FRAME

68 → #66 – #75

SITZFLÄCHE/
SEAT

#57

RÜCKENLEHNE/GESTELL - BACKREST/FRAME

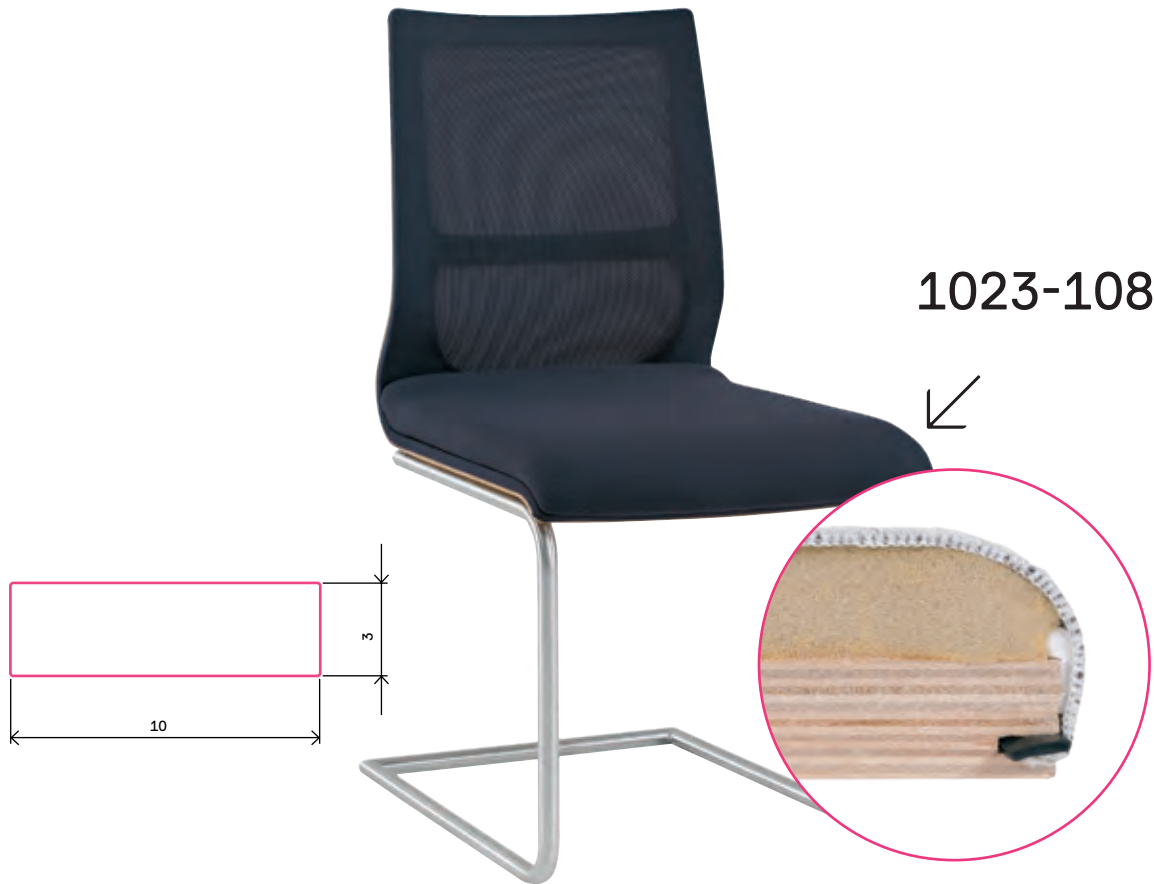

#57 WEICHES FLACHBAND/
SOFT FLAT STRIP

NO.	DESCRIPTION	PU	DIMENSIONS
1023-108	zum Einstecken in Nuten, mit Markierungen und Ausstanzungen to plug in grooves with marks and cuttings	Rollen à 200 m rolls at 200 m each	Breite: 10 mm width: 10 mm

2288-000
33009-10999



23125-999

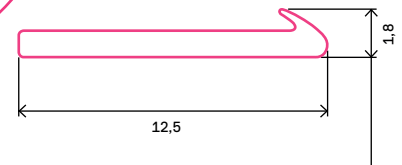
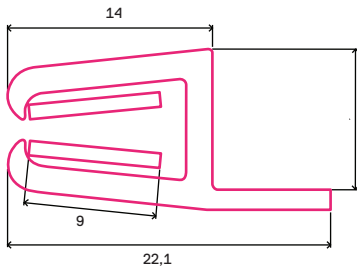

#58 FLACHBAND MIT WIDERHAKEN/ FLAT STRIP WITH BARB

NO.	DESCRIPTION	PU	DIMENSIONS
23125-999	zum Einstecken in Nuten to plug in grooves	Rollen à 500 m rolls at 500 m each	Breite: 12,5 mm width: 12.5 mm



#59 VERSCHLUSSSYSTEM/ LOCK SYSTEM

NO.	DESCRIPTION	PU	DIMENSIONS
2288-000	Profil mit Kunststoffflanke zum Tackern profile with plastic flange for stapling	100 Stück 100 pcs.	Länge: 1.200 mm length: 1.200 mm
33009-10999	Gegenleiste counter-bar	Rollen à 1.500 m rolls at 1,500 m each	1 x 9 mm 1 x 9 mm



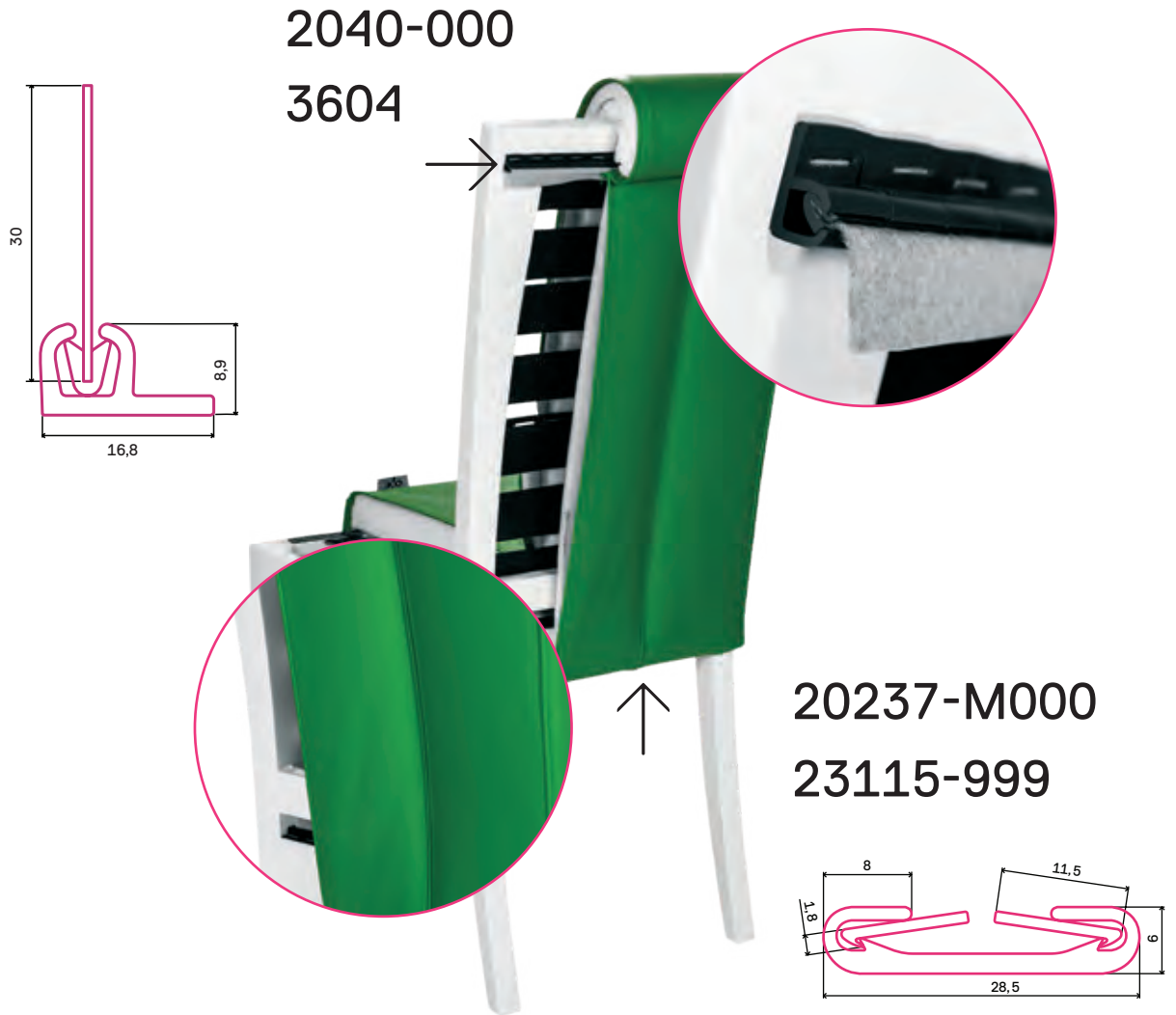

#60 DOPPELVERSCHLUSSSYSTEM/ DOUBLE LOCK SYSTEM

NO.	DESCRIPTION	PU	DIMENSIONS
20237-M000	Profil für zwei Stoffbahnen, ohne Einschnitte profile for two fabric panels without cuts	50 Stück 50 pcs.	Länge: 1.200 mm length: 1,200 mm
23115-999	Gegenleiste counter-bar	Rollen à 500 m rolls at 500 m each	Breite: 11,5 mm width: 11.5 mm



#61 LINIEN-ABHEFTSYSTEM/ PLEATLINE TUFTING SYSTEM

NO.	DESCRIPTION	PU	DIMENSIONS	FLANGE LENGTH
2040-000	Führungsschiene mit Kunststoffflanke guide rod with plastic flange	100 Stück 100 pcs.	Länge: 1.200 mm length: 1,200 mm	
3604	TieDown für besonders schnelle Verarbeitung TieDown for very fast processing	auf Anfrage on request	Stab: 4,5 x 5,4 mm rail: 4.5 x 5.4 mm	15-80 mm



→
4370-032
3694

#62 CLIPFIX FÜR KISSEN/ CLIPFIX FOR PILLOWS

NO.	DESCRIPTION	PU	DIMENSIONS	FLANGE LENGTH
4370-032	 ClipFix kurz ClipFix short	120 Stück 120 pcs.	Länge: 400 mm length: 400 mm	
3694	 TieDown für besonders feste Verbindung TieDown for very fixed connection	auf Anfrage on request	Stab: 5,5 x 6,6 mm rod: 5.5 x 6.6 mm	15-80 mm 15-80 mm

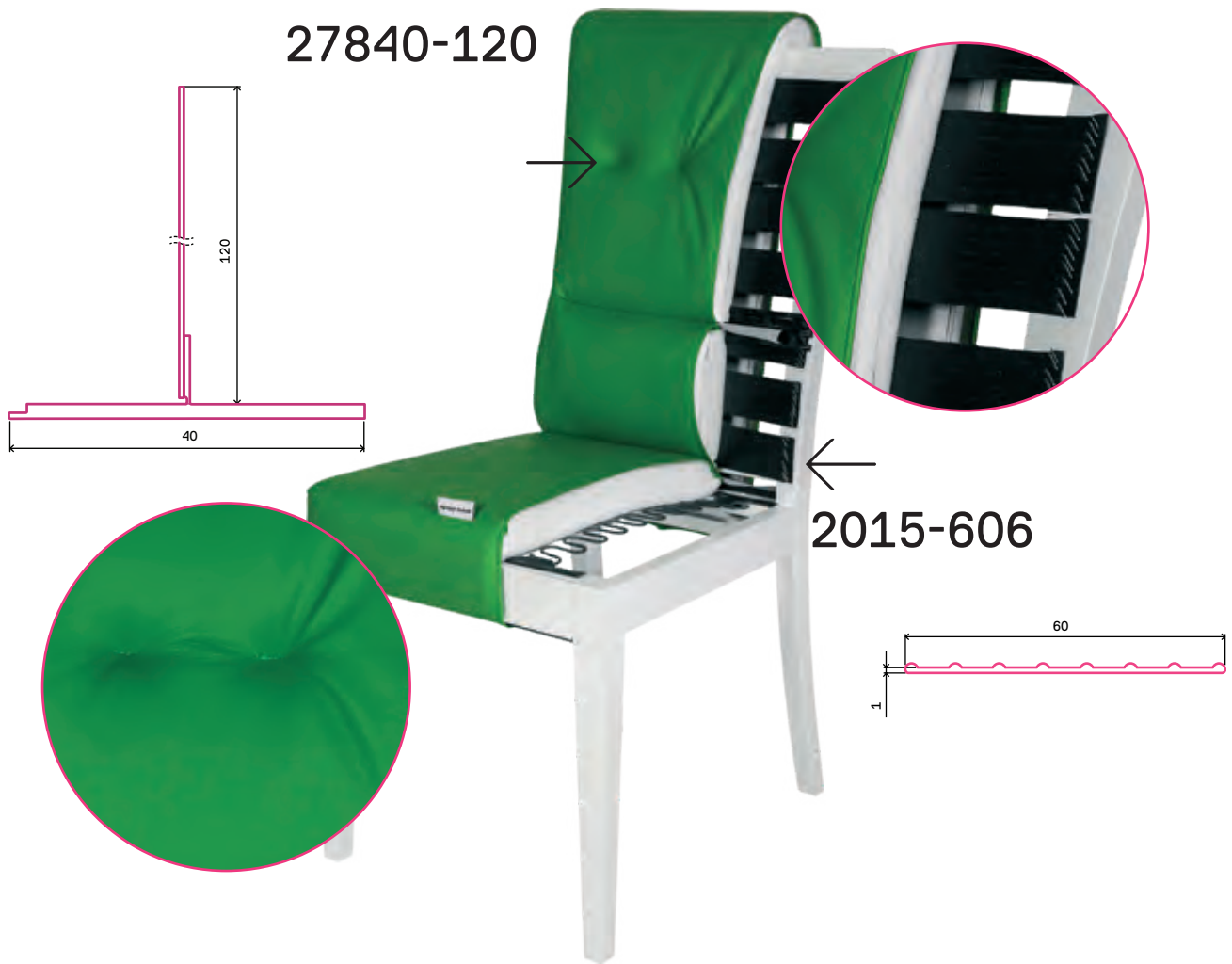

#63 PUNKTABHEFTSTEG/ SINGLE TUFTING STRIP



NO.	DESCRIPTION	PU	DIMENSIONS	FLANGE LENGTH
27840-120	 Abheftsteg mit fest verbundenem Vliesstreifen tufting system with firmly attached non-woven flange	1.000 Stück 1.000 pcs.	Steg: 40 mm strip: 40 mm	120 mm 120 mm

#64 KLAMMERSTREIFEN/ STAPLING STRIP

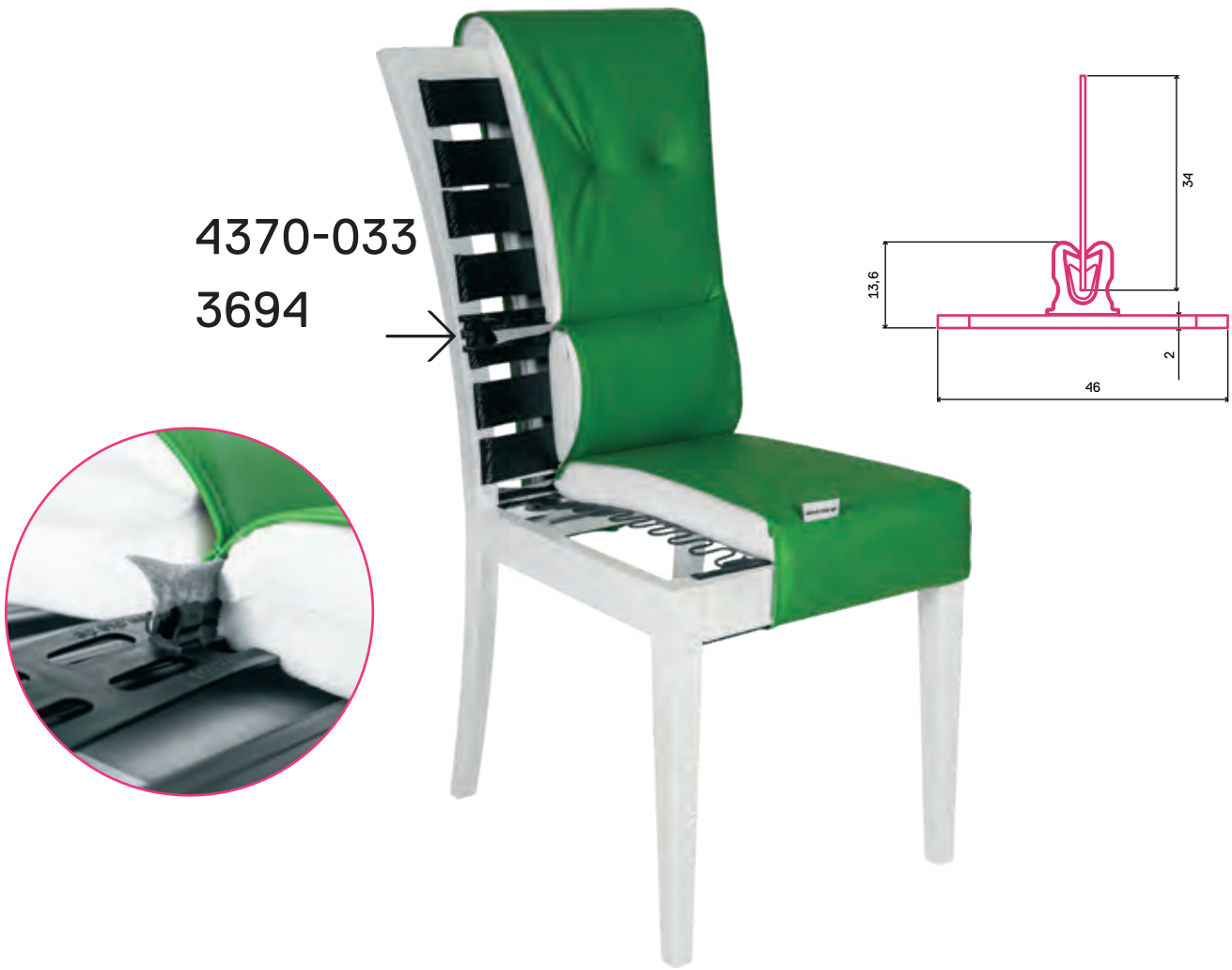
NO.	DESCRIPTION	PU	DIMENSIONS
2015-606	 mit Führungsrillen für sicheres Tackern with guide grooves for safe stapling	Rollen à 150 m rolls at 150 m each	60 mm 60 mm



#65 CLIPFIX-SYSTEM/ CLIPFIX-SYSTEM

NO.	DESCRIPTION	PU	DIMENSIONS	FLANGE LENGTH
4370-033	 ClipFix lang ClipFix long	40 Stück 40 pcs.	Länge: 800 mm length: 800 mm	
3694	 TieDown für besonders feste Verbindung TieDown for very fixed connection	auf Anfrage on request	Stab: 5,5 x 6,6 mm rod: 5.5 x 6.6 mm	15-80 mm 15-80 mm



#66 WEICHES FLACHBAND/ SOFT FLAT STRIP

NO.	DESCRIPTION	PU	DIMENSIONS
1023-108	zum Einstecken in Nuten, mit Markierungen und Ausstanzungen to plug in grooves with marks and cuttings	Rollen à 200 m rolls at 200 m each	Breite: 10 mm width: 10 mm

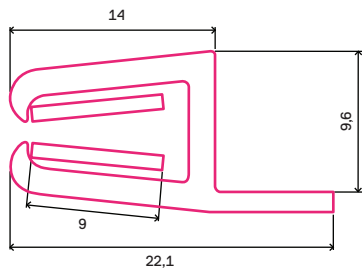

2288-000

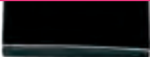

33009-10999

#67 VERSCHLUSSSYSTEM/ LOCK SYSTEM

NO.	DESCRIPTION	PU	DIMENSIONS
2288-000	 Profil mit Kunststoffflanke zum Tackern profil with plastic flange for stapling	100 Stück 100 pcs.	Länge: 1.200 mm length: 1,200 mm
33009-10999	 Gegenleiste counter-bar	Rollen à 1.500 m rolls at 1,500 m each	1 x 9 mm 1 x 9 mm

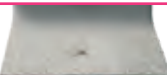

#68 ABHEFTSYSTEM/ TUFTING SYSTEM

NO.	DESCRIPTION	PU	DIMENSIONS	FLANGE LENGTH
4370-036	 Single clip single clip	5.000 Stück 5,000 pcs.	Platte: 30 x 40 mm board: 30 x 40 mm	
3604	 TieDown für besonders schnelle Verarbeitung TieDown for very fast processing	auf Anfrage on request	Stab: 4,5 x 5,4 mm rod: 4.5 x 5.4 mm	15-80 mm 15-80 mm
5980-0001	 Vliesstreifen mit Lochstanzungen non-woven with hole punchings	Rollen à 200 m rolls at 200 m each	Abstand Einschnitte: 80 mm cut distance: 80 mm	80 mm 80 mm



27840-120

#69 PUNKTABHEFTSTEG/ SINGLE TUFTING STRIP

NO.	DESCRIPTION	PU	DIMENSIONS	FLANGE LENGTH
27840-120	Abheftsteg mit fest verbundenem Vliesstreifen tufting system with firmly attached non-woven flange	1.000 Stück 1,000 pcs.	Steg: 40 mm strip: 40 mm	120 mm 120 mm



#70

SITZFLÄCHE - SEAT



#70 KLEMMPROFIL/ FASTENING PROFILE

NO.	DESCRIPTION	PU	DIMENSIONS	FLANGE LENGTH
2700-000	mit Vliesfahne für Blechstärken 1,5 - 2,5 mm with non-woven flange for metal sheets 1.5 - 2.5 mm	75 Stück 75 pcs.	Länge: 1.200 mm length: 1,200 mm	10 mm 10 mm

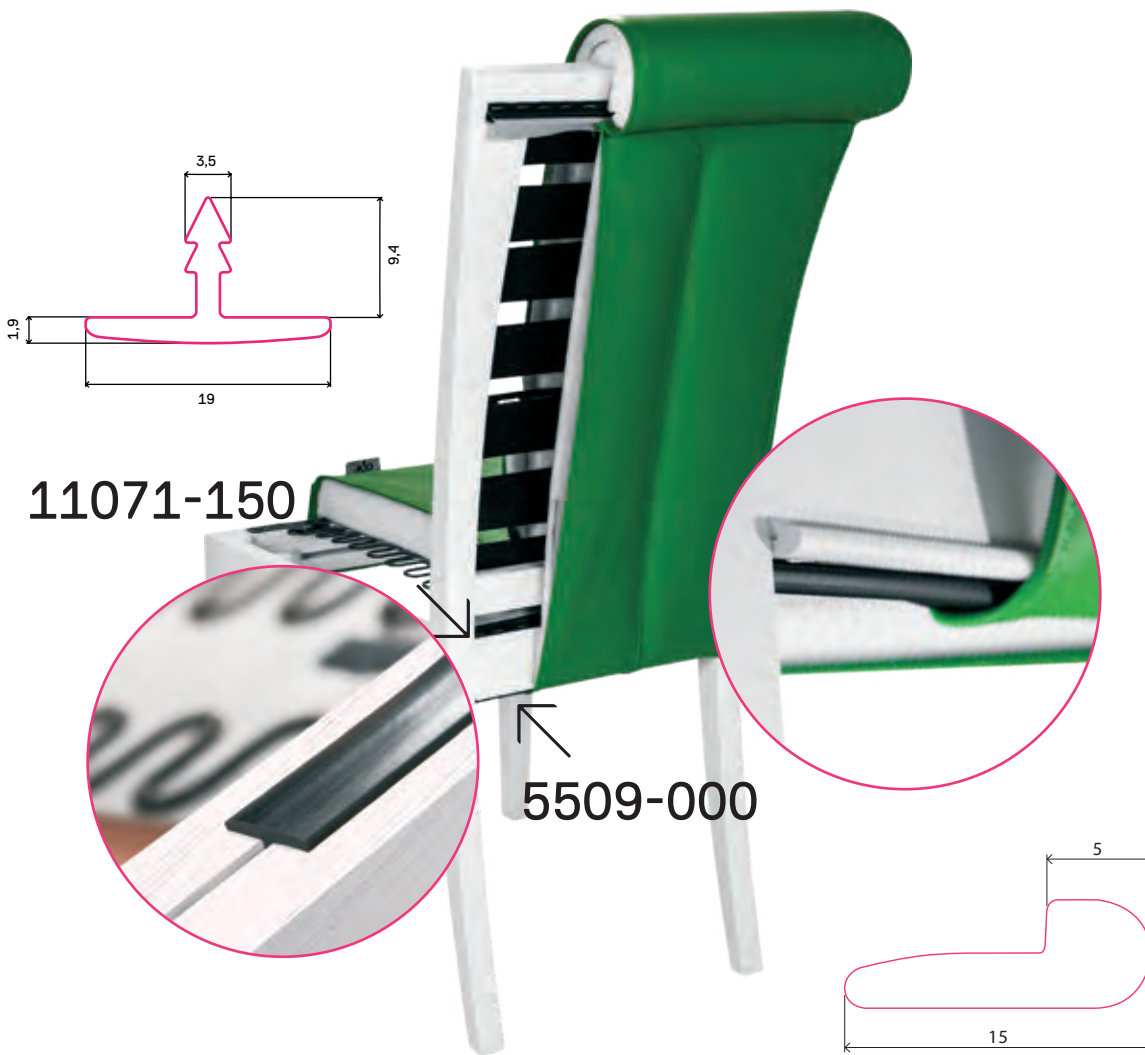

#71 SCHLAUCHKEDER/ EDGE TRIM

NO.	DESCRIPTION	PU	DIMENSIONS
5509-000	mit dezentem Kantenschutz with unobtrusive edge protection	250 Stück 250 pcs.	Länge: 1.200 mm length: 1,200 mm

#72 STECKPROFIL/ PLUG-IN PROFILE

NO.	DESCRIPTION	PU	DIMENSIONS
11071-150	mit Oberflächenwölbung with surface curvature	100 Stück 100 pcs.	Länge: 1.500 mm length: 1,500 mm

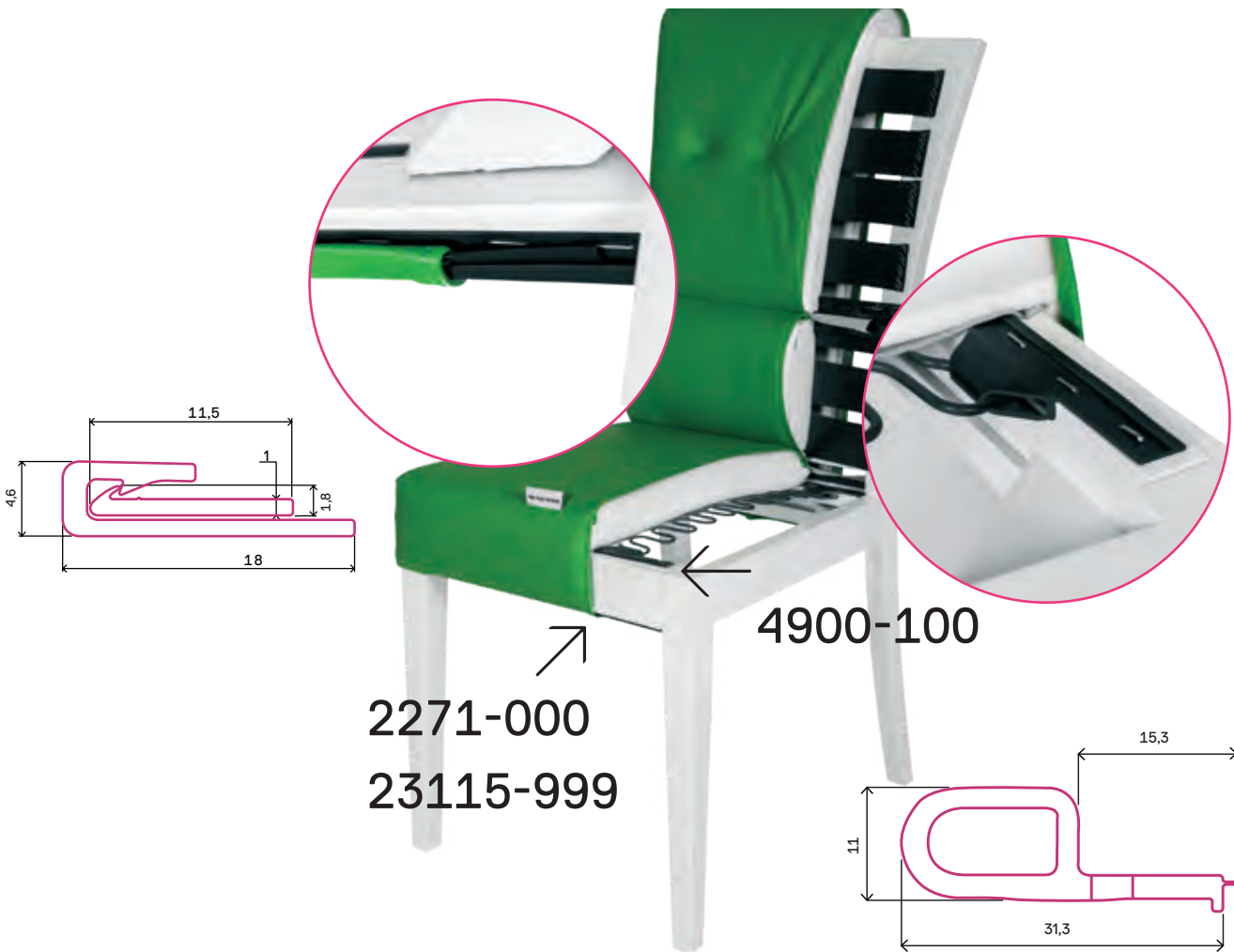

#73 VERSCHLUSSSYSTEM/ LOCK SYSTEM

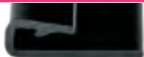
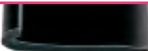
NO.	DESCRIPTION	PU	DIMENSIONS
2271-000	 Verschlussprofil mit Widerhaken lock profile with barb	250 Stück 250 pcs.	Länge: 1.200 mm length: 1,200 mm
23115-999	 Gegenleiste counter-bar	Rollen à 500 m rolls at 500 m each	Breite: 11,5 mm width: 11.5 mm

#74 SCHARNIERLEISTE/ CLIP STRIP

NO.	DESCRIPTION	PU	DIMENSIONS
4900-100	 zur Befestigung von Wellenfedern im und auf dem Rahmen for zigzag spring attachment in and on the frame	2.200 Stück 2,200 pcs.	Clipabstand: 100 mm clip distance: 100 mm

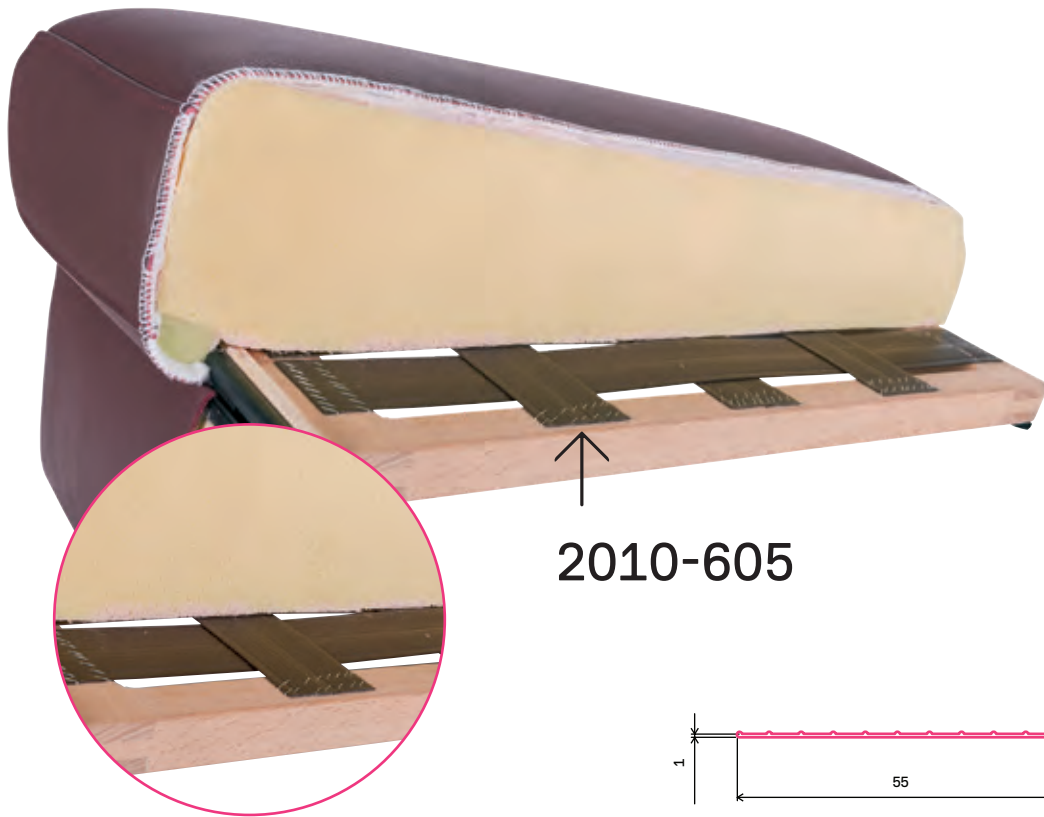

#75 KUNSTSTOFFGURT/ PLASTIC BELT

NO.	DESCRIPTION	PU	DIMENSIONS
2010-605	Gurt mit besonders hoher Belastbarkeit für Holzrahmen, mit Verstärkungsflächen belt with extra high resilience for wooden frame, with reinforcing areas	Rollen à 200 m rolls at 200 m each	Breite: 56 mm width: 56 mm



BÜROMÖBEL

Nichts geht schneller, als Stoffe, Netzgewebe oder Leder mit unseren Flachbändern in die Nuten des Sitzrahmens zu clipsen.

OFFICE FURNITURE

Nothing is faster as clipping fabrics, mesh oder leather into the grooves of the seat frame when using our flat strips.

BÜRO- MÖBEL/ OFFICE FURNITURE

Federleichte Drehstühle, nur mit einem dünnen Netz bespannt, millimetergenau auf die Körpergröße einstellbar. So sehen heute hochwertige Büromöbel aus. Dazu kommen mobile Trennwände und Media-Möbel, die viel Technik beinhalten. Um die besonders hohen Anforderungen in diesem Bereich erfüllen zu können, benötigt man viele besondere Verbindungs- und Funktionselemente, die schon in der Entwicklung einer neuen Serie berücksichtigt werden.

Lightweight swivel chairs, covered with just a thin mesh, and precisely adjustable to the body size. This is how high quality office furniture looks today. There are also mobile partitions and media furniture including a lot of technology. In order to meet the stringent requirements in this field, you need many special types of connection and functional elements, which are already taken into account throughout the development of a new series.

78 → #76 – #77

**KOPFSTÜTZE/
HEADREST**

79 → #78 – #84

**RÜCKENLEHNE/
BACKREST**

86 → #85 – #87

**SITZFLÄCHE/
SEAT**

2288-000

33009-10999

Variante für eine Polsterkopfstütze
version for upholstered headrest

1905-000

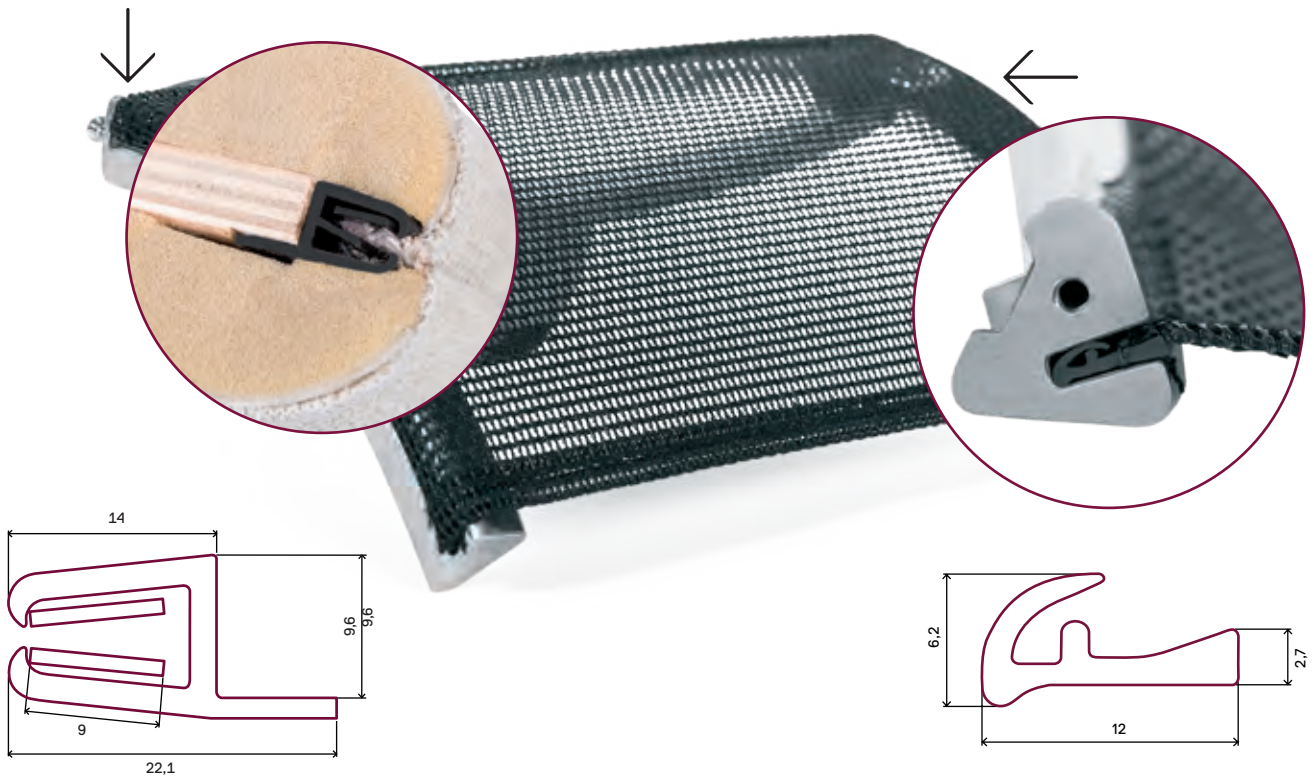

#76 EINSTECKPROFIL/ STICK PROFILE

NO.	DESCRIPTION	PU	DIMENSIONS
1905-000	mit Widerhaken für Metallnuten with barb for metal grooves	250 Stück 250 pcs.	Länge: 1.200 mm length: 1,200 mm

#77 VERSCHLUSSSYSTEM/ LOCK SYSTEM

NO.	DESCRIPTION	PU	DIMENSIONS
2288-000	Profil mit Fahne zum Tackern profile with flange for stapling	100 Stück 100 pcs.	Länge: 1.200 mm length: 1,200 mm
33009-10999	Gegenleiste counter-bar	Rollen à 1.500 m rolls at 1,500 m each	1 x 9 mm 1 x 9 mm



#78 WEICHES FLACHBAND/
SOFT FLAT STRIP

NO.	DESCRIPTION	PU	DIMENSIONS
10231-108	zum Einstecken in Nuten, mit Markierungen und Ausstanzungen to plug in grooves, with marks and punchings	Rollen à 200 m rolls at 200 m each	10 x 3 mm 10 x 3 mm

#79

RÜCKENLEHNE - BACKREST



#79 EINSTECKPROFIL/ STICK PROFILE

NO.	DESCRIPTION	PU	DIMENSIONS
1630-000	mit Widerhaken für Metallnuten with barb for metal grooves	200 Stück 200 pcs.	Länge: 1.200 mm length: 1,200 mm



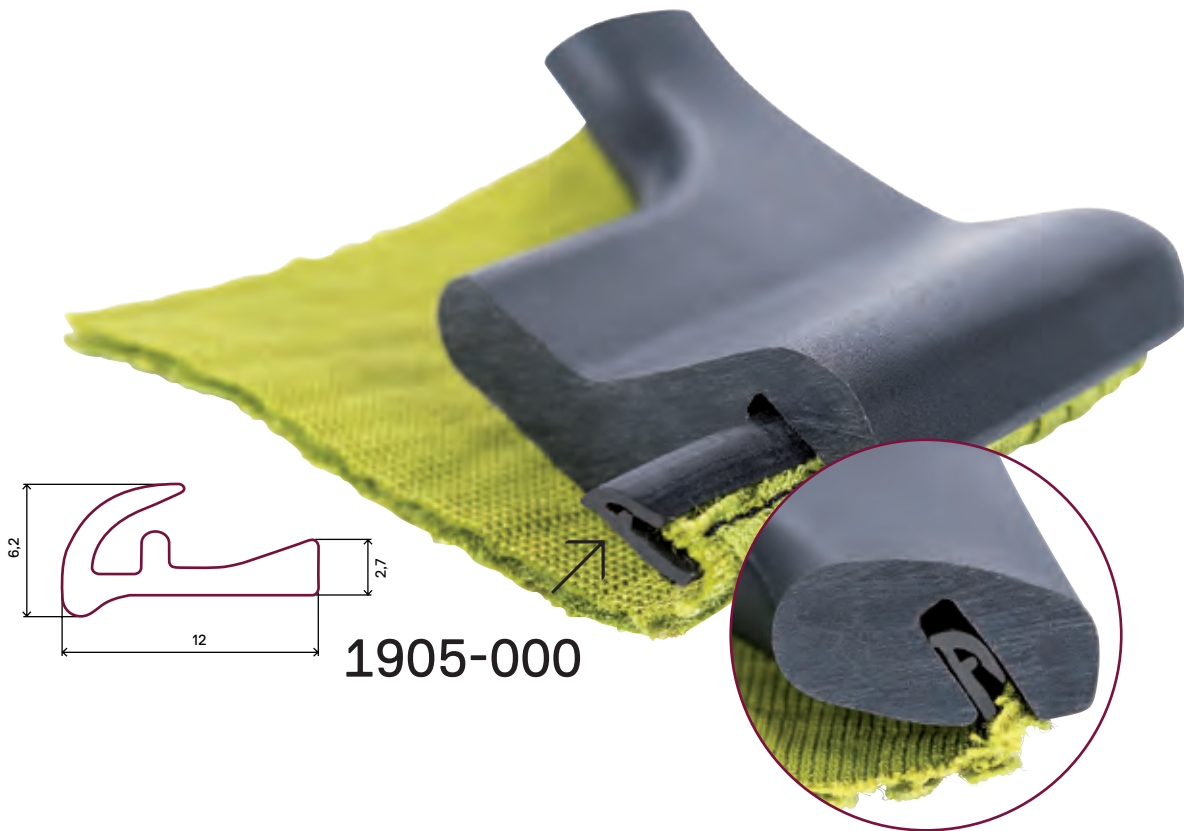

#80 EINSTECKPROFIL/ STICK PROFILE

NO.	DESCRIPTION	PU	DIMENSIONS
1905-000	 mit Klemmwirkung in der Nut und Ausgleich der Nuttoleranz with clamping effect and tolerance compensation of the groove	250 Stück 250 pcs.	Länge: 1.200 mm length: 1,200 mm

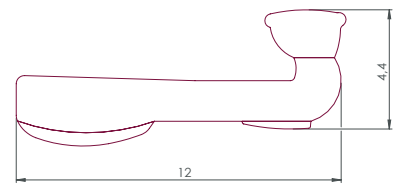

#81 EINSTECKPROFIL/ STICK PROFILE

NO.	DESCRIPTION	PU	DIMENSIONS
1748	Mehrkomponentenprofil für eine optimale Haftung in der Nut multi-component profile for optimal adhesion in the groove	auf Anfrage on request	Länge: 1.200 mm Length: 1,200 mm





#82 KLAMMERSTREIFEN/ STAPLING STRIP

NO.	DESCRIPTION	PU	DIMENSIONS
3074-120	 mit Führungsrillen für sicheres Tackern with guide grooves for safe stapling	Rolle à 1.000 mm rolls at 1,000 mm	12 x 1 mm 12 x 1 mm





#83 ABHEFTSYSTEM/ TUFTING SYSTEM

NO.	DESCRIPTION	PU	DIMENSIONS	FLANGE LENGTH
4370-011	 3er Clipleiste zum Tackern triple clip profile for stapling	500 Stück 500 pcs.	Länge: 270 mm length: 270 mm	
3694	 TieDown für besonders feste Verbindung TieDown for very fixed connection	auf Anfrage on request	Stab: 5,5 x 6,6 mm rod: 5,5 x 6,6 mm	15-80 mm 15-80 mm



#84 VERSCHLUSSSYSTEM/ LOCK SYSTEM

NO.	DESCRIPTION	PU	DIMENSIONS
2298-000	 Verschlussprofil mit Widerhaken lock profil with barb	150 Stück 150 pcs.	Länge: 1.200 mm length: 1,200 mm
2297-000	 Gegenleiste mit Kugel counter-bar with ball	300 Stück 300 pcs.	Länge: 1.200 mm length: 1,200 mm



#85 CLIPFIX-SYSTEM/ CLIPFIX SYSTEM

NO.	DESCRIPTION	PU	DIMENSIONS	FLANGE LENGTH
4370-032	 ClipFix kurz ClipFix short	120 Stück 120 pcs.	Länge: 400 mm length: 400 mm	
3694	 TieDown für besonders feste Verbindung TieDown for very fixed connection	auf Anfrage on request	Stab: 5,5 x 6,6 mm rod: 5.5 x 6.6 mm	15-80 mm 15-80 mm

#86

SITZFLÄCHE - SEAT



#86 WEICHES FLACHBAND/ SOFT FLAT STRIP

NO.	DESCRIPTION	PU	DIMENSIONS
10231-108	zum Einstecken in Nuten to plug in grooves	Rollen à 200 m rolls at 200 m each	10 x 3 mm 10 x 3 mm

#87

SITZFLÄCHE - SEAT



#87 TIEDOWN/ TIEDOWN

NO.	DESCRIPTION	PU	DIMENSIONS	FLANGE LENGTH
3604	als Einsteckprofil für besonders feste Verbindung as stick profile for very fixed connection	auf Anfrage on request	Stab: 4,5 x 5,4 mm rod: 4.5 x 5.4 mm	15-80 mm



RECLINER

FoamFlex-Produkte eignen sich besonders gut als Füll- und Polster Elemente. Dank der angebrachten Fahne aus Vlies kann FoamFlex auch angenäht werden.

RECLINER

FoamFlex elements are especially useful for filling and cushioning elements. Thanks to the integrated non-woven flange, FoamFlex can be sewn too.

RECLINER/ RECLINERS

Sich reinsetzen und wohlfühlen – Recliner sind individuell einstellbar und bieten unterschiedliche Funktionen. Denn immer häufiger werden Elemente aus dem Autositzbereich, wie Kopfstützen, bewegliche Arm- oder Fußteile und elektrische Bedienfunktionen, auch in der Möbelbranche eingesetzt. Bei den Entwicklungsprojekten kommen uns die langjährigen Erfahrungen aus der Automobilbranche besonders zugute.

Sit down and feel at ease – recliners are individually adjustable and offer various features. Headrests, movable armrests or foot supports and electrical control functions from the car seat sector are becoming more common elements now also used in the furniture industry. When developing these new furniture projects, our many years of experience in the automotive industry are of particular benefit to us.

92 → #88 – #89
**KOPFSTÜTZE/
HEADREST**

104 → #102 – #111
**SITZFLÄCHE/
SEAT**

94 → #90 – #94
**RÜCKENLEHNE/
BACKREST**

98 → #95 – #101
**ARMLEHNE/
ARMREST**

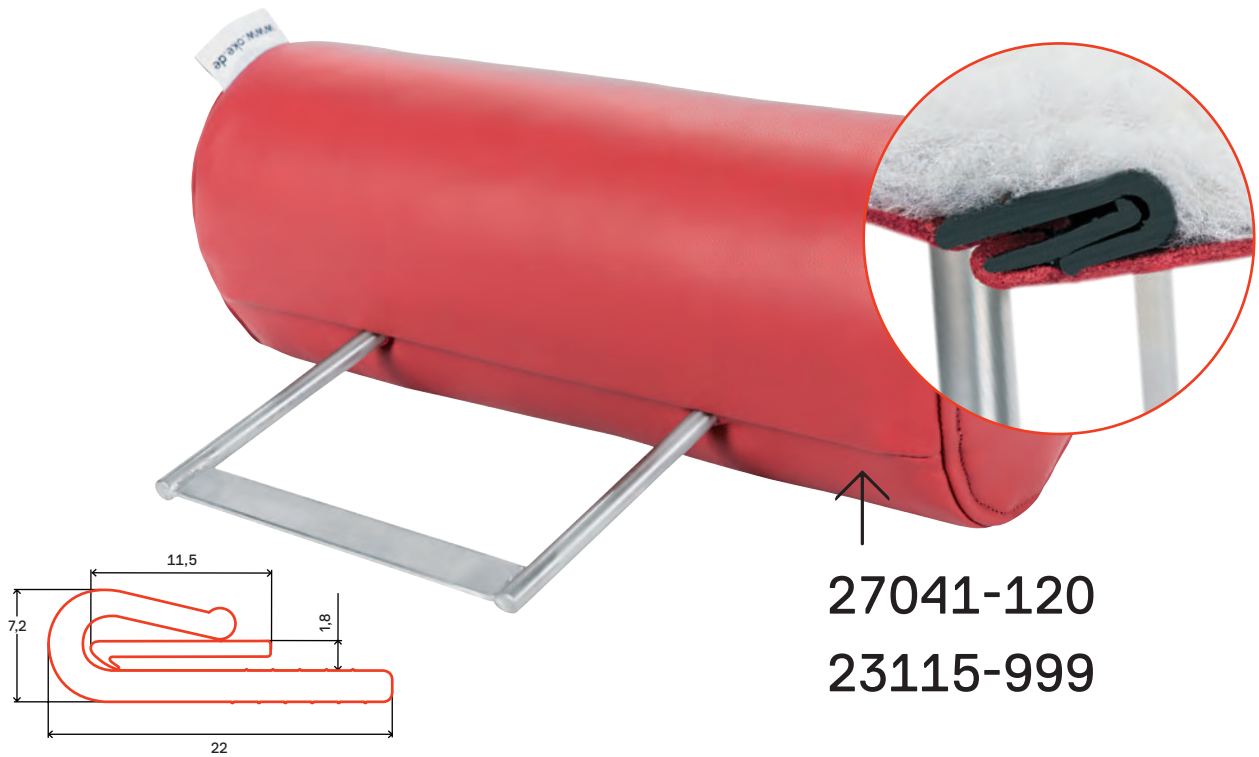

#88

KOPFSTÜTZE – HEADREST



27041-120
23115-999

#88 VERSCHLUSSSYSTEM/ LOCK SYSTEM

NO.	DESCRIPTION	PU	DIMENSIONS
27041-120 	Verschlussprofil ohne Widerhaken lock profile without barb	150 Stück 150 pcs.	Länge: 1.200 mm length: 1,200 mm
23115-999 	Gegenleiste counter-bar	Rollen à 500 m rolls at 500 m each	Breite: 11,5 mm width: 11.5 mm



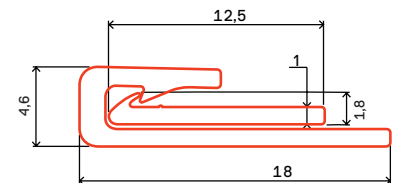

2271-000

23125-999



#89 VERSCHLUSSSYSTEM/ LOCK SYSTEM

NO.	DESCRIPTION	PU	DIMENSIONS	ADDITIONAL INFO
2271-000	 Verschlussprofil ohne Widerhaken lock profile without barb	250 Stück 250 pcs.	Länge: 1.200 mm length: 1.200 mm	Nr. 129 no 129
23125-999	 Gegenleiste counter-bar	Rollen à 500 m rolls at 500 m each	Breite: 12,5 mm width: 12.5 mm	Nr. 144 no 144

#90

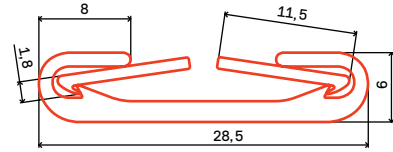

RÜCKENLEHNE – BACK REST

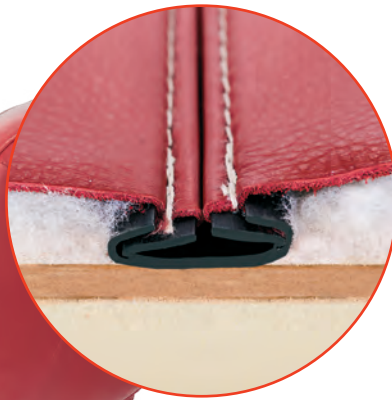

20237-M000
23115-999



#90 DOPPELVERSCHLUSSSYSTEM/ DOUBLE LOCK SYSTEM



NO.	DESCRIPTION	PU	DIMENSIONS
20237-M000	 Verschlussprofil für zwei Stoffbahnen, ohne Einschnitte lock profile for two fabric oanelns without cuts	50 Stück 50 pcs.	Länge: 1.200 mm length: 1,200 mm
23115-999	 Gegenleiste counter-bar	Rollen à 500 m rolls at 500 m each	Breite: 11,5 mm width: 11.5 mm



4370-033
3694

← 4370-036
3604

#91 ABHEFTSYSTEM/ TUFTING SYSTEM

NO.	DESCRIPTION	PU	DIMENSIONS	FLANGE LENGTH
4370-036	 Single clip single clip	5.000 Stück 5,000 pcs.	Platte: 30 x 40 mm board: 30 x 40 mm	
3604	 TieDown für besonders schnelle Verarbeitung TieDown for very fast processing	auf Anfrage on request	Stab: 4,5 x 5,4 mm rod: 4.5 x 5.4 mm	15-80 mm 15-80 mm

#92 CLIPFIX-SYSTEM/ CLIPFIX-SYSTEM

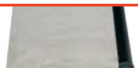
NO.	DESCRIPTION	PU	DIMENSIONS	FLANGE LENGTH
4370-033	 ClipFix lang ClipFix long	40 Stück 40 pcs.	Länge: 800 mm length: 800 mm	
3694	 TieDown für besonders feste Verbindung TieDown for very fixed connection	auf Anfrage on request	Stab: 5,5 x 6,6 mm rod: 5.5 x 6.6 mm	15-80 mm 15-80 mm

#93

RÜCKENLEHNE – BACKREST



#93 PUNKTABHEFTSTEG/ SINGLE TUFTING STRIP

NO.	DESCRIPTION	PU	DIMENSIONS	FLANGE LENGTH
27840-120	Abheftsteg mit fest verbundenem Vliesstreifen tufting strip with firmly attached non-woven flange	1.000 Stück 1,000 pcs.	Steg: 40 mm strip: 40 mm	120 mm 120 mm





4370-036
3604
5980-0001

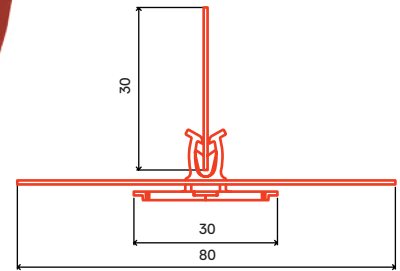

#94 ABHEFTSYSTEM/ TUFTING SYSTEM

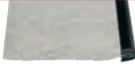
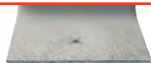
NO.	DESCRIPTION	PU	DIMENSIONS	FLANGE LENGTH
4370-036	 Single clip single clip	5.000 Stück 5,000 pcs.	Platte: 30 x 40 mm board: 30 x 40 mm	
3604	 TieDown für besonders schnelle Verarbeitung TieDown for very fast processing	auf Anfrage on request	Stab: 4,5 x 5,4 mm rod: 4.5 x 5.4 mm	15-80 mm 15-80 mm
5980-0001	 Vliesstreifen mit Lochstanzungen non-woven with hole punchings	Rollen à 200 m rolls at 200 m each	Abstand Einschnitte: 80 mm cut distance: 80 mm	80 mm 80 mm

#95

ARMLEHNE – ARMREST

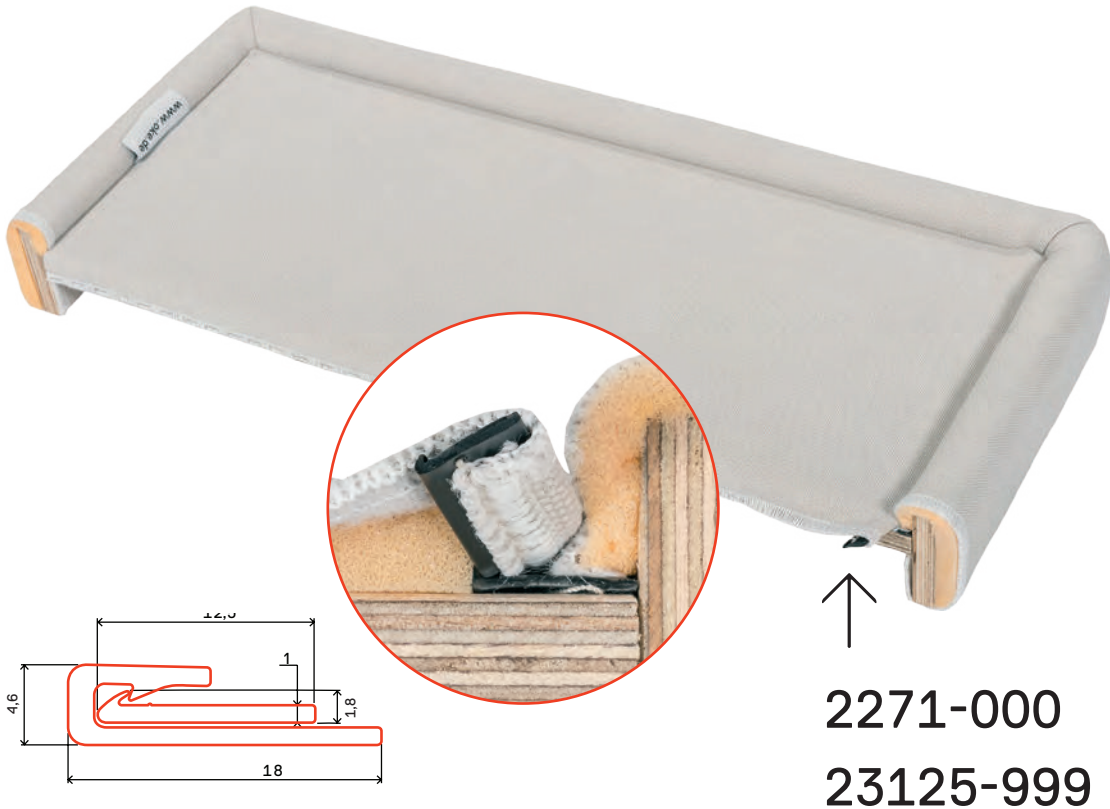

2271-000

23125-999

#95 VERSCHLUSSSYSTEM LOCK SYSTEM

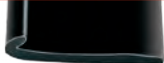
NO.	DESCRIPTION	PU	DIMENSIONS
2271-000	 Verschlussprofil mit Widerhaken lock profile with barb	250 Stück 250 pcs.	Länge: 1.200 mm length: 1,200 mm
23125-999	 Gegenleiste counter-bar	Rollen à 500 m rolls at 500 m each	Breite: 12,5 mm width: 12.5 mm

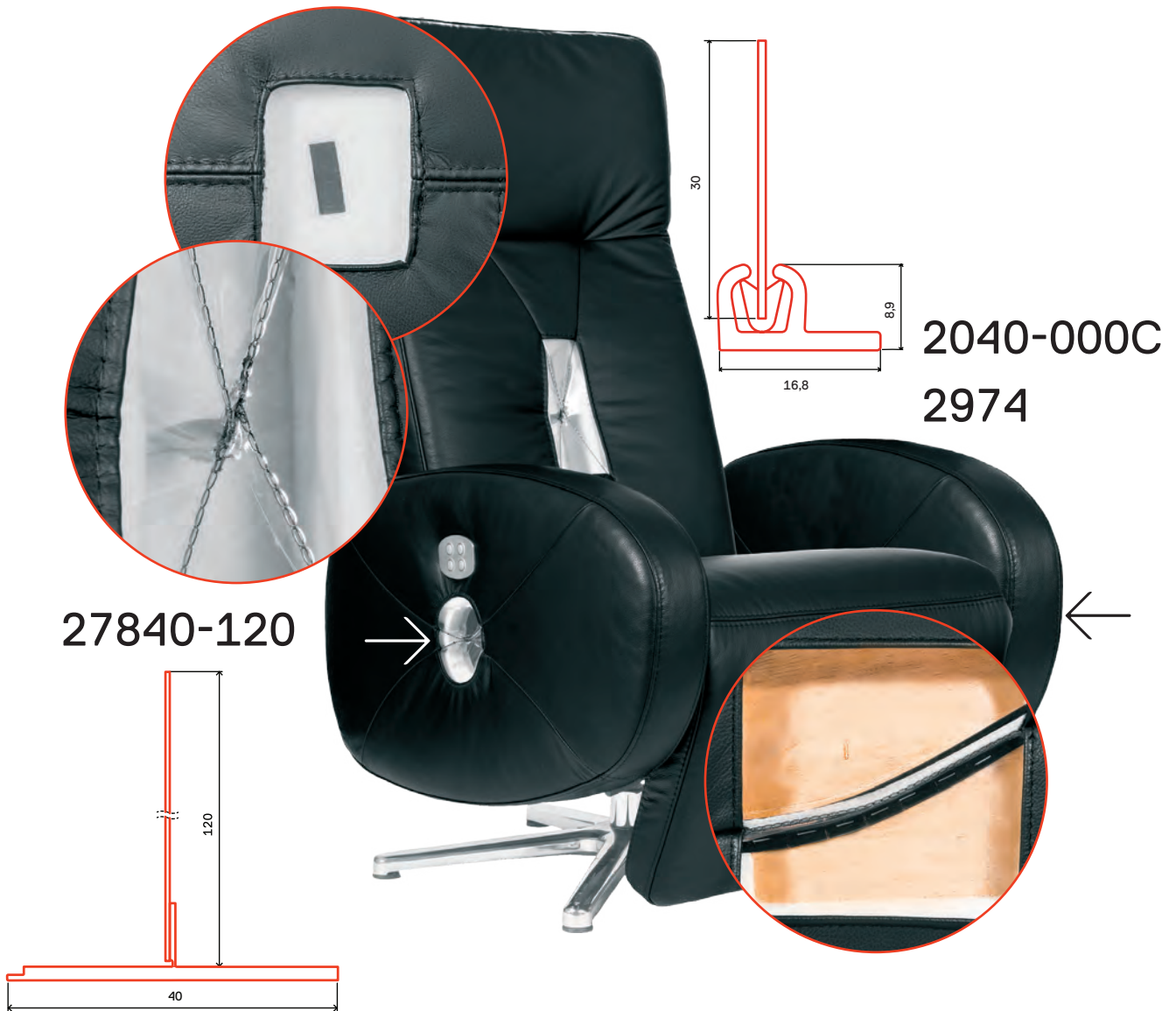

#96 PUNKTABHEFTSTEG/ SINGLE TUFTING STRIP

NO.	DESCRIPTION	PU	DIMENSIONS	FLANGE LENGTH
27840-120	Abheftsteg mit fest verbundenem Vliesstreifen	1.000 Stück	Steg: 40 mm	120 mm
	tufting strip with firmly attached non-woven flange	1,000 pcs.	strip: 40 mm	120 mm

#97 ABHEFTSYSTEM FÜR LEICHTE RADII/ TUFTING SYSTEM FOR SLIGHT RADII



NO.	DESCRIPTION	PU	DIMENSIONS	FLANGE LENGTH
2040-000C	Clipprofil mit Fahne und Einschnitten	100 Stück	Länge: 1.200 mm	
	clip profile with flange and cuts	100 pcs.	length: 1,200 mm	
2974	TieDown für besonders schnelle Verarbeitung	auf Anfrage	Stab: 4,0 x 5,1 mm	15-80 mm
	TieDown for very fast processing	on request	rod: 4.0 x 5.1 mm	15-80 mm

2040-000C

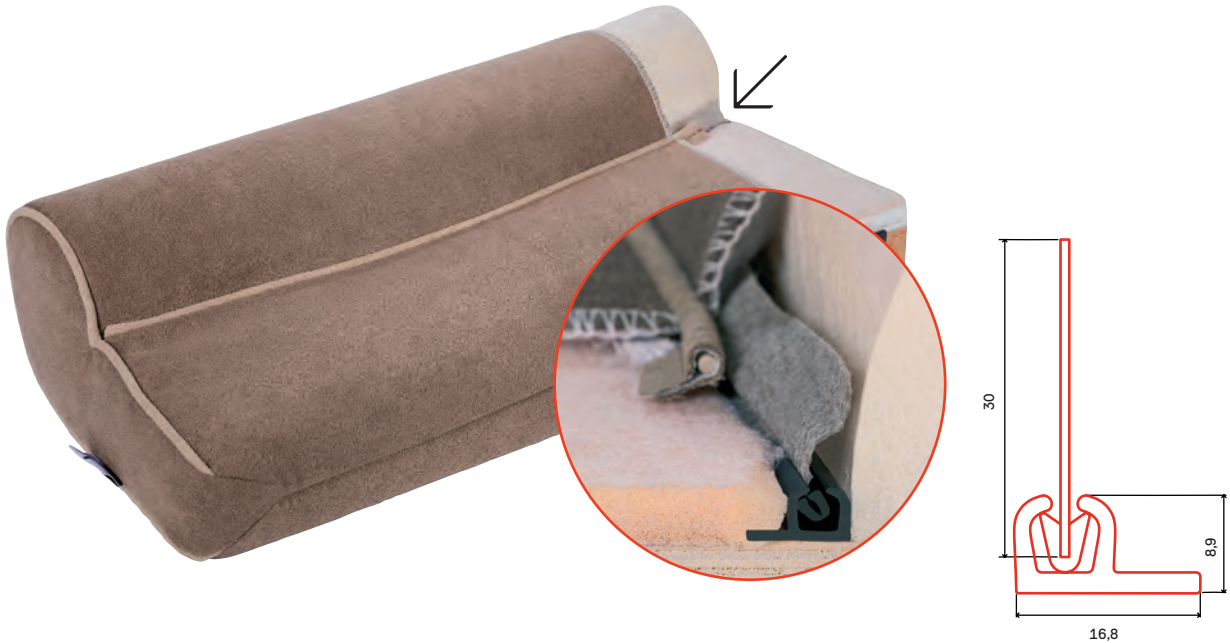
2974





#98 ABHEFTSYSTEM FÜR LEICHTE RADII/ TUFTING SYSTEM FOR SLIGHT RADII

NO.	DESCRIPTION	PU	DIMENSIONS	FLANGE LENGTH
2040-000C	 Clippprofil mit Kunststoffflanke und Einschnitten clip profile with plastic flange and cuts	100 Stück 100 pcs.	Länge: 1.200 mm length: 1,200 mm	
2974	 TieDown für besonders schnelle Verarbeitung TieDown for very fast processing	auf Anfrage on request	Stab: 4,0 x 5,1 mm rod: 4.0 x 5.1 mm	15-80 mm 15-80 mm



#99 LINIEN-ABHEFTSYSTEM/ PLEATLINE TUFTING SYSTEM

NO.	DESCRIPTION	PU	DIMENSIONS	FLANGE LENGTH
2040-000	 Clippprofil mit Fahne clip profile with flange	100 Stück 100 pcs.	Länge: 1.200 mm length: 1,200 mm	
2974	 TieDown für besonders schnelle Verarbeitung TieDown for very fast processing	auf Anfrage on request	Stab: 4,0 x 5,1 mm rod: 4.0 x 5.1 mm	15-80 mm 15-80 mm

#100

ARMLEHNE - ARMREST



50097-180

#100 SCHLAUCHKEDER/ EDGE TRIM

NO.	DESCRIPTION	PU	DIMENSIONS
50097-180	breite und runde Geometrie broad and round shape	Rollen à 130 m rolls at 130 m each	Ø 18 mm Ø 18 mm

#101

ARMLEHNE – ARMREST

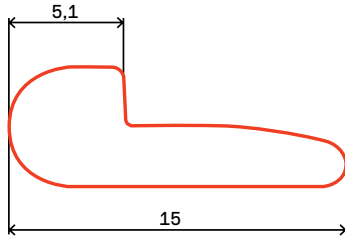

#101 SCHLAUCHKEDER EDGE TRIM

NO.	DESCRIPTION	PU	DIMENSIONS
5509-000	mit dezentem Kantenschutz with unobtrusive edge protection	250 Stück 250 pcs.	Länge: 1.200 mm length: 1,200 mm



#102

SITZFLÄCHE – SEAT

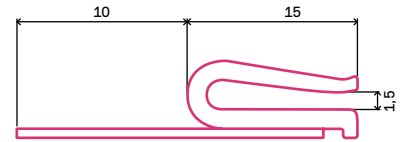

2700-000

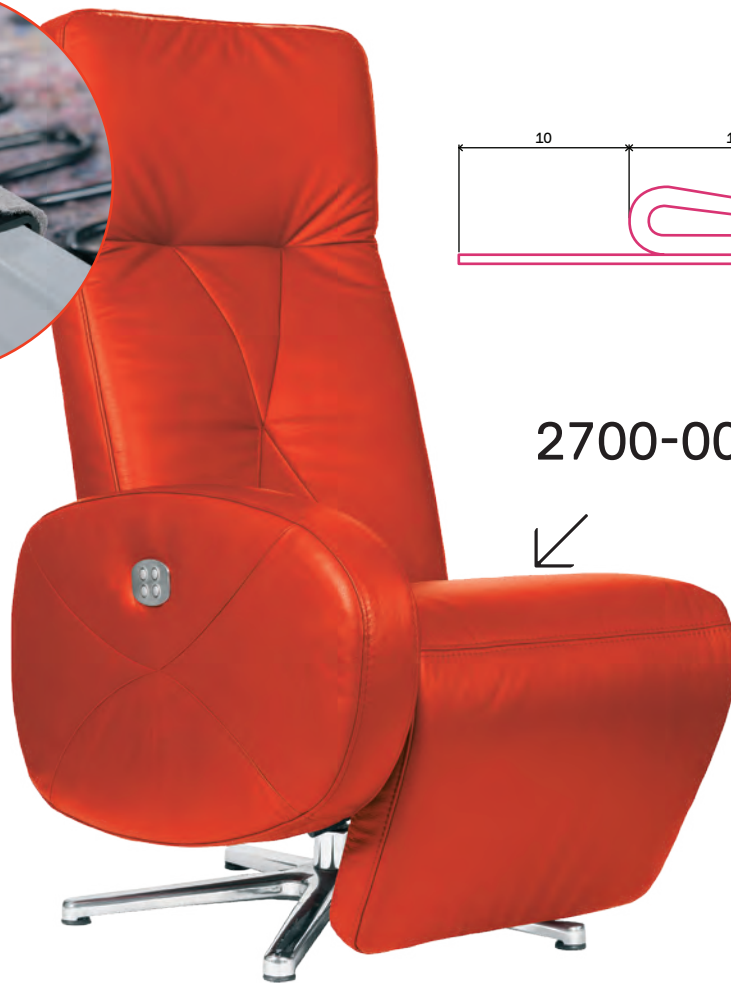

#102 KLEMMPROFIL/ FASTENING PROFILE

NO.	DESCRIPTION	PU	DIMENSIONS	FLANGE LENGTH
2700-000	mit Vliesfahne, für Blechstärken 1,5 - 2,5 mm with non-woven flange, for metal sheets 1.5 - 2.5 mm	75 Stück 75 pcs.	Länge: 1.200 mm length: 1,200 mm	10 mm 10 mm

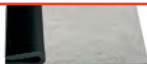

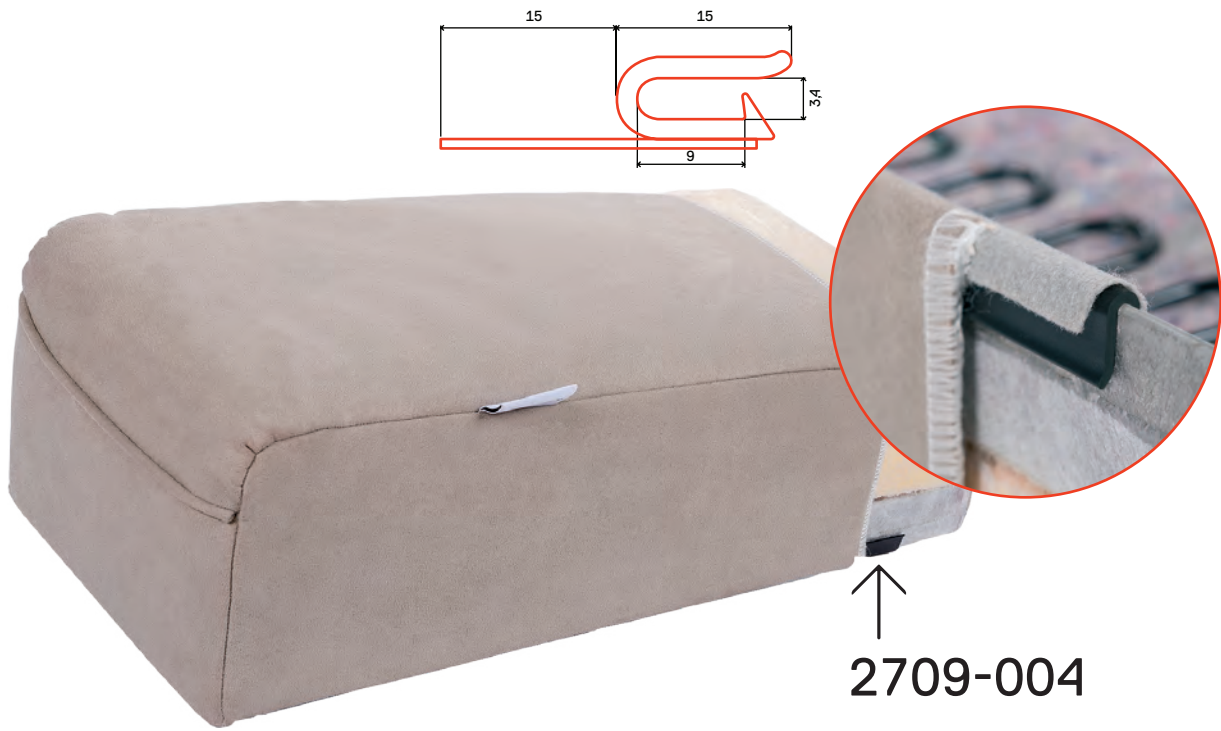

#103 HAKENPROFIL HOOK PROFILE

NO.	DESCRIPTION	PU	DIMENSIONS	FLANGE LENGTH
2709-004	mit Vliesfahne with non-woven flange	100 Stück 100 pcs.	Länge: 1.200 mm length: 1.200 mm	15 mm 15 mm



#104

SITZFLÄCHE – SEAT



1003-000

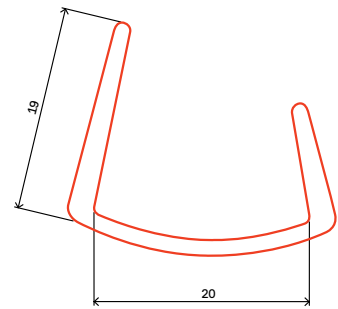

#104 U-PROFIL U-PROFILE

NO.	DESCRIPTION	PU	DIMENSIONS
1003-000	zum Anclipsen von Stoffen for clipping on fabrics	40 Stück 40 pcs.	Länge: 1.000 mm length: 1,000 mm





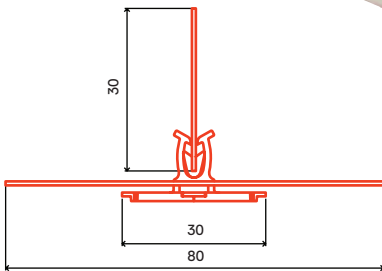
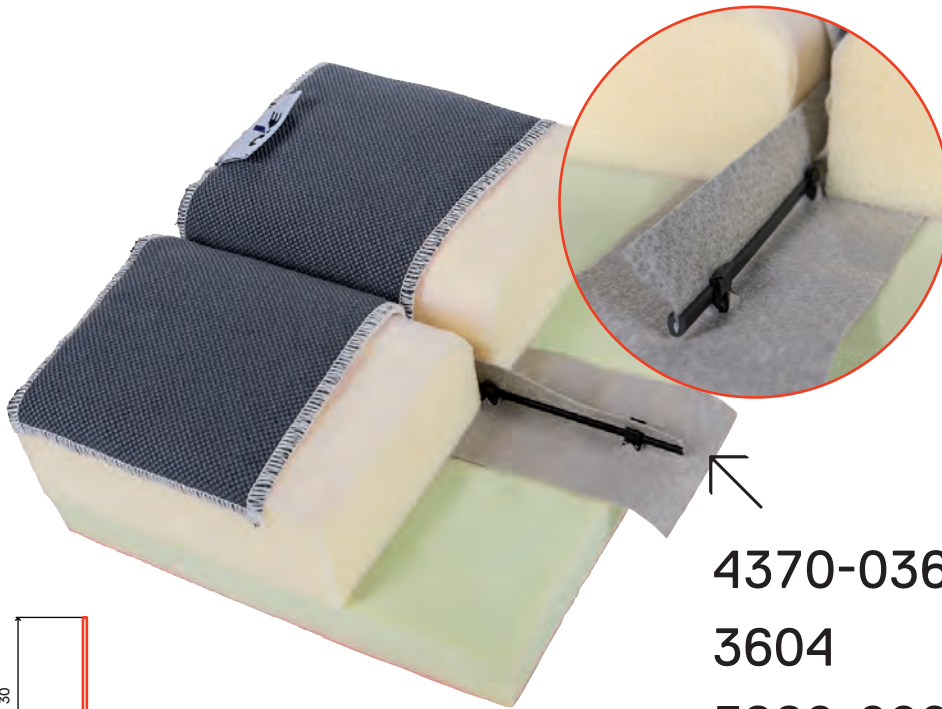

#105 ABHEFTSYSTEM/ TUFTING SYSTEM

NO.	DESCRIPTION	PU	DIMENSIONS	FLANGE LENGTH
4370-036	 <p>Single clip für Formschaum single clip for moulded foam</p>	5.000 Stück 5,000 pcs.	Platte: 30 x 40 mm plate: 30 x 40 mm	
3604	 <p>TieDown für besonders schnelle Verarbeitung TieDown for very fast processing</p>	auf Anfrage on request	Stab: 4,5 x 5,4 mm rod: 4.5 x 5.4 mm	15-80 mm 15-80 mm



4370-036
3604
5980-0001

#106 ABHEFTSYSTEM/ TUFTING SYSTEM

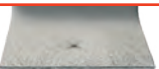
NO.	DESCRIPTION	PU	DIMENSIONS	FLANGE LENGTH
4370-036	 Single clip single clip	5.000 Stück 5,000 pcs.	Platte: 30 x 40 mm board: 30 x 40 mm	
3604	 TieDown für besonders schnelle Verarbeitung TieDown for very fast processing	auf Anfrage on request	Stab: 4,5 x 5,4 mm rod: 4.5 x 5.4 mm	15-80 mm 15-80 mm
5980-0001	 Vliesstreifen mit Lochstanzung non-woven with hole punchings	Rollen à 200 m rolls at 200 m each	Abstand Einschnitte: 80 mm cut distance: 80 mm	80 mm 80 mm



27856-046

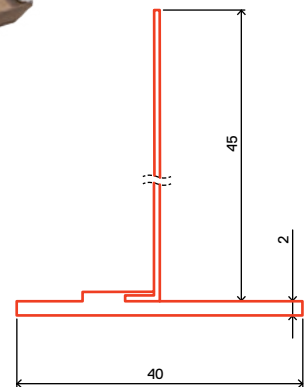

#107 EINZUGSTECKSTREIFEN/ FLUTING STRIP

NO.	DESCRIPTION	PU	DIMENSIONS	FLANGE LENGTH
27856-046	ohne Gegenleiste, einfach querstellen without counter-bar, just set across	75 Stück 75 pcs.	Länge: 1.200 mm length: 1,200 mm	46-120 mm 46-120 mm



#108

SITZFLÄCHE – SEAT



27840-120

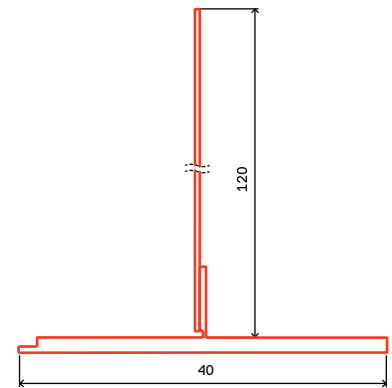

#108 PUNKTABHEFTSTEG/ SINGLE TUFTING STRIP

NO.	DESCRIPTION	PU	DIMENSIONS	FLANGE LENGTH
27840-120	Abheftsteg mit fest verbundenem Vliesstreifen tufting strip with firmly attached non-woven flange	1.000 Stück 1.000 pcs.	Steg: 40 mm strip: 40 mm	120 mm 120 mm

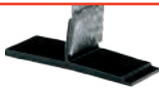

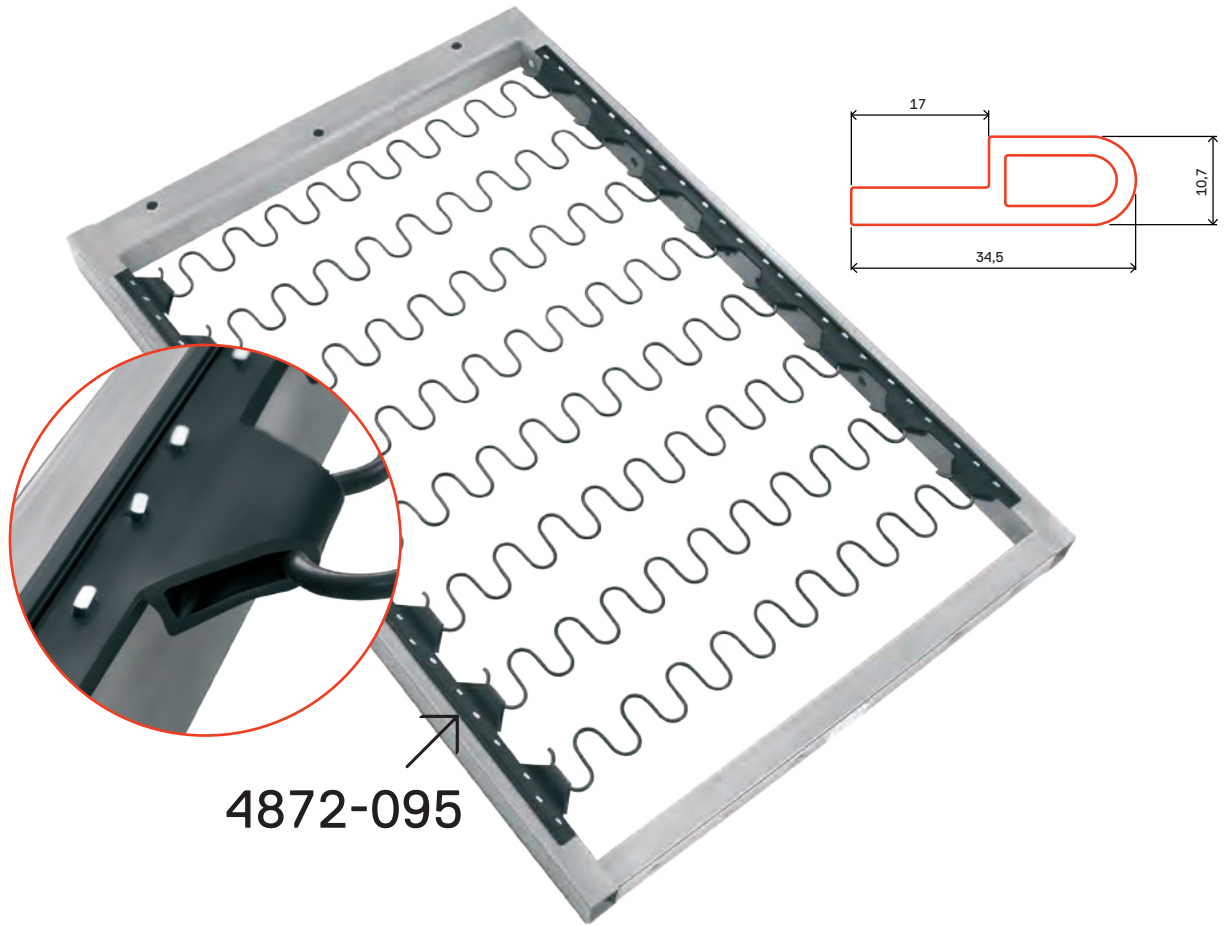

#109 SCHARNIERLEISTE/ CLIP STRIP

NO.	DESCRIPTION	PU	DIMENSIONS
4872-095	zur Befestigung von Wellenfedern im Rahmen for zigzag spring attachment in the frame	2.000 Stück 2,000 pcs.	Clipabstand: 95 mm clip distance: 95 mm



#110

SITZFLÄCHE – SEAT



#110 CLIP STRIP PLUS/ CLIP STRIP PLUS

NO.	DESCRIPTION	PU	DIMENSIONS
4900-100	zur Befestigung von Wellenfedern im und auf dem Rahmen for zigzag spring attachment in and on the frame	2.200 Stück 2,200 pcs.	Clipabstand: 100 mm clip distance: 100 mm

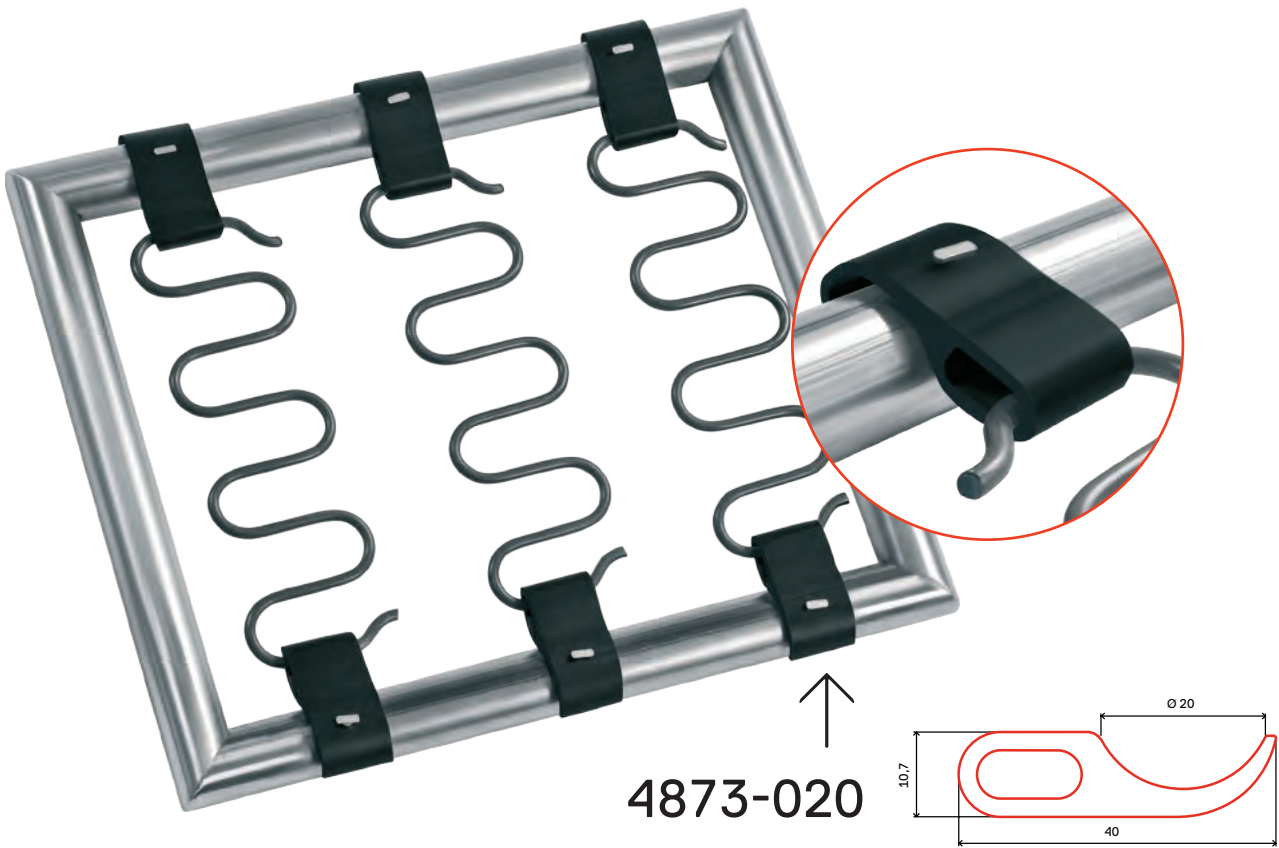

#111 EINZELCLIP/ SINGLE CLIP

NO.

DESCRIPTION

PU

DIMENSIONS

4873-020



zur Befestigung von Wellenfedern in Rundrohr-Rahmen
for zigzag spring attachment in tubular frames

4.000 Stück
4,000 pcs.

Länge: 20 mm
length: 20 mm



BETTEN

Unsere FoamFlex-Produkte gibt es in verschiedenen Härtegraden, als Füll- oder Kantenschutzelement. Für alle, die es bequem haben möchten.

BEDS

Our FoamFlex products are available in differing hardness degrees, as filling or as edge protection elements. For those who prefer to have comfort.

BETTEN/ BEDS

Betten werden immer häufiger ergonomisch gestaltet, an individuelle Bedürfnisse angepasst und mit Funktionen ausgestattet. Klassische OKE-Profile treffen hier auf Innovationen aus der Polstermöbel- und Automobilindustrie. Verstellbare Kopf- und Fußteile werden ebenso integriert, wie massive Boxspring-Unterbauten oder Unterfederungen der Liegefläche. Auch kunstvolle Rückenteile mit Rechteck-Steppungen werden mit unseren kleinen Helfern viel einfacher umgesetzt!



Sleeping comfort will continue to gain importance in the future, with beds becoming more than just a simple mattress. Beds are increasingly ergonomically designed to suit individual needs and are equipped with features. Classic OKE profiles join forces with innovations from the upholstery and automotive industries. Adjustable head and footrests as well as massive box-spring substructures or lower suspensions of the bedding surface are integrated here. In addition, artistic rear parts with square quilting can be implemented much more easily with our little helpers!

116 → #112 – #119
**KOPFTEIL/
HEADBOARD**

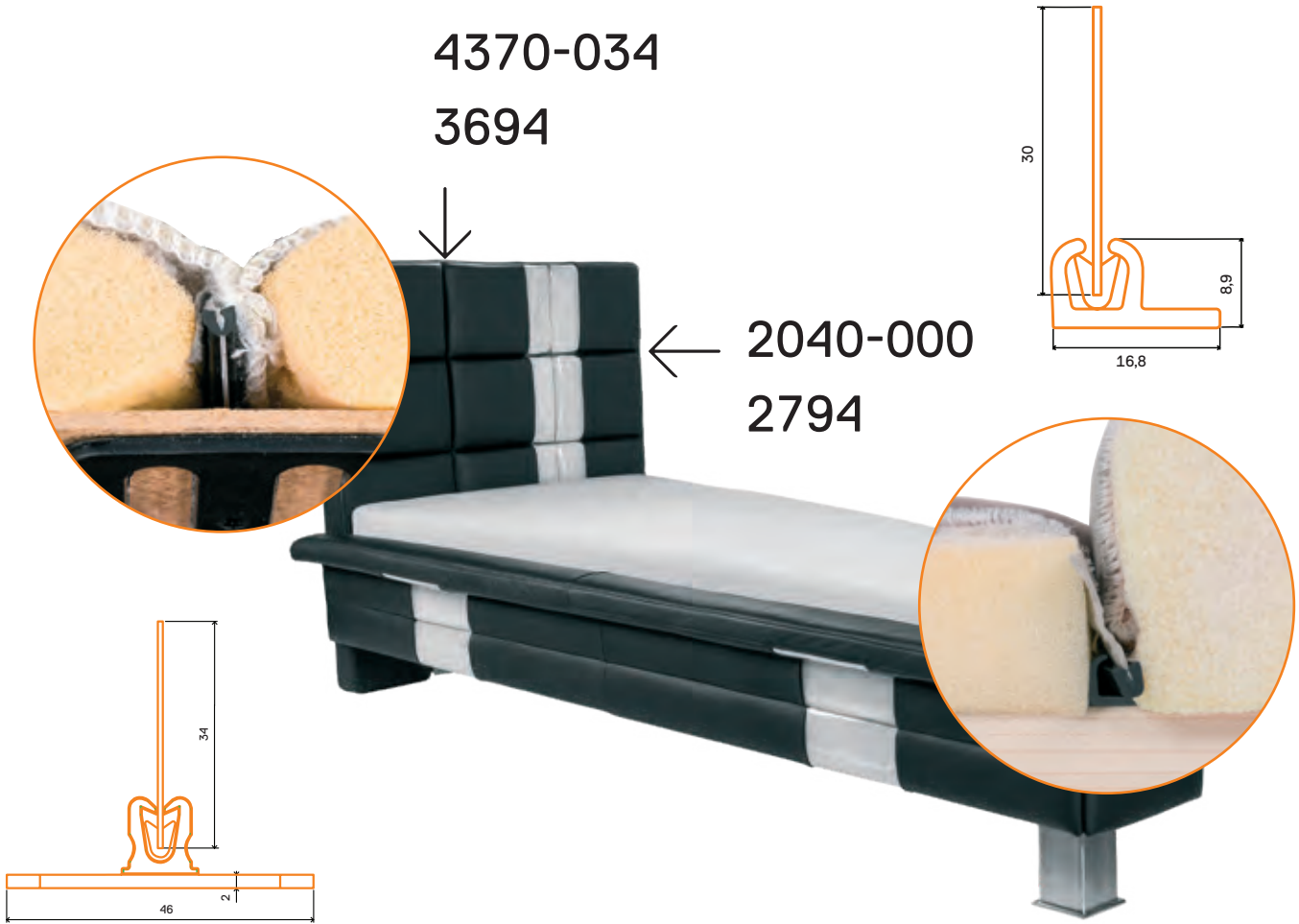
123 → #120 – #123
**WANGE/
SIDEBOARD**



#112 CLIPFIX-SYSTEM/ CLIPFIX SYSTEM

NO.	DESCRIPTION	PU	DIMENSIONS	FLANGE LENGTH
4370-034	 ClipFix extra lang ClipFix extra long	40 Stück 40 pcs.	Länge: 1.200 mm length: 1,200 mm	
3694	 TieDown für eine sehr feste Verbindung TieDown for very fixed connection	auf Anfrage on request	Stab: 5,5 x 6,6 mm rod: 5.6 x 6.6 mm	15-80 mm 15-80 mm

#113 LINIENABHEFTSYSTEM PLEATLINE TUFTING SYSTEM

NO.	DESCRIPTION	PU	DIMENSIONS	FLANGE LENGTH
2040-000	 Führungsschiene mit Kunststoffflanke guide rail with plastic flange	100 Stück 100 pcs.	Länge: 1.200 mm length: 1,200 mm	
2794	 TieDown für besonders schnelle Verarbeitung TieDown for very fast processing	auf Anfrage on request	Stab: 4,0 x 5,1 mm rod: 4.0 x 5.1 mm	15-80 mm 15-80 mm

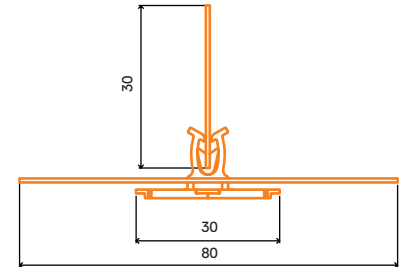
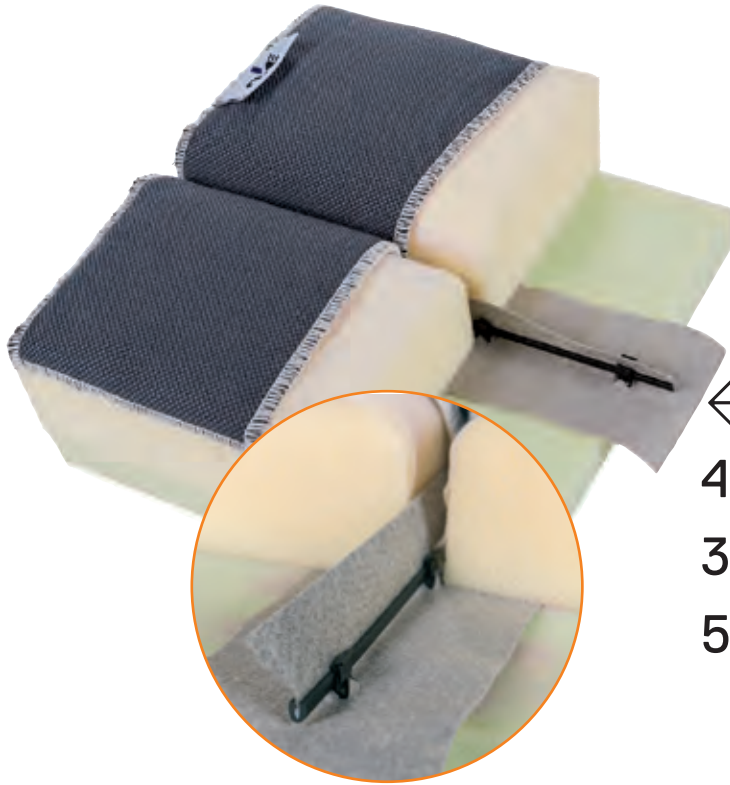

←
4370-036
3604
5980-0001

#114 ABHEFTSYSTEM/ TUFTING SYSTEM

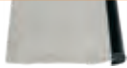
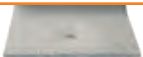
NO.	DESCRIPTION	PU	DIMENSIONS	FLANGE LENGTH
4370-036	 Single clip Single clip	5.000 Stück 5,000 pcs.	Platte: 30 x 40 mm board: 30 x 40 mm	
3604	 TieDown für besonders schnelle Verarbeitung TieDown for very fast processing	auf Anfrage on request	Stab: 4,5 x 5,4 mm rod: 4.5 x 5.4 mm	15-80 mm 15-80 mm
5980-0001	 Vliesstreifen mit Lochstan- zungen non-woven with hole punchings	Rollen à 200 m rolls at 200 m each	Abstand Einschnitte: 80 mm cut distance: 80 mm	80 mm 80 mm

#115

KOPFTEIL – HEADBOARD

27840-120

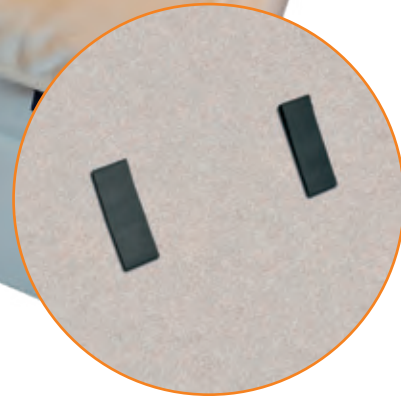
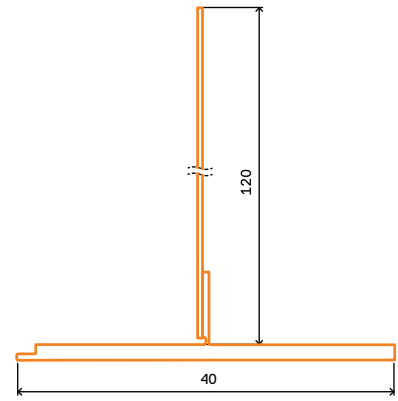

#115 PUNKTABHEFTSTEG/ SINGLE TUFTING STRIP

NO.	DESCRIPTION	PU	DIMENSIONS	FLANGE LENGTH
27840-120	 Steg mit fest verbundenem Vliesstreifen strip with firmly attached non-woven flange	1.000 Stück 1,000 pcs.	Steg: 40 mm strip: 40 mm	120-220 mm 120-220 mm

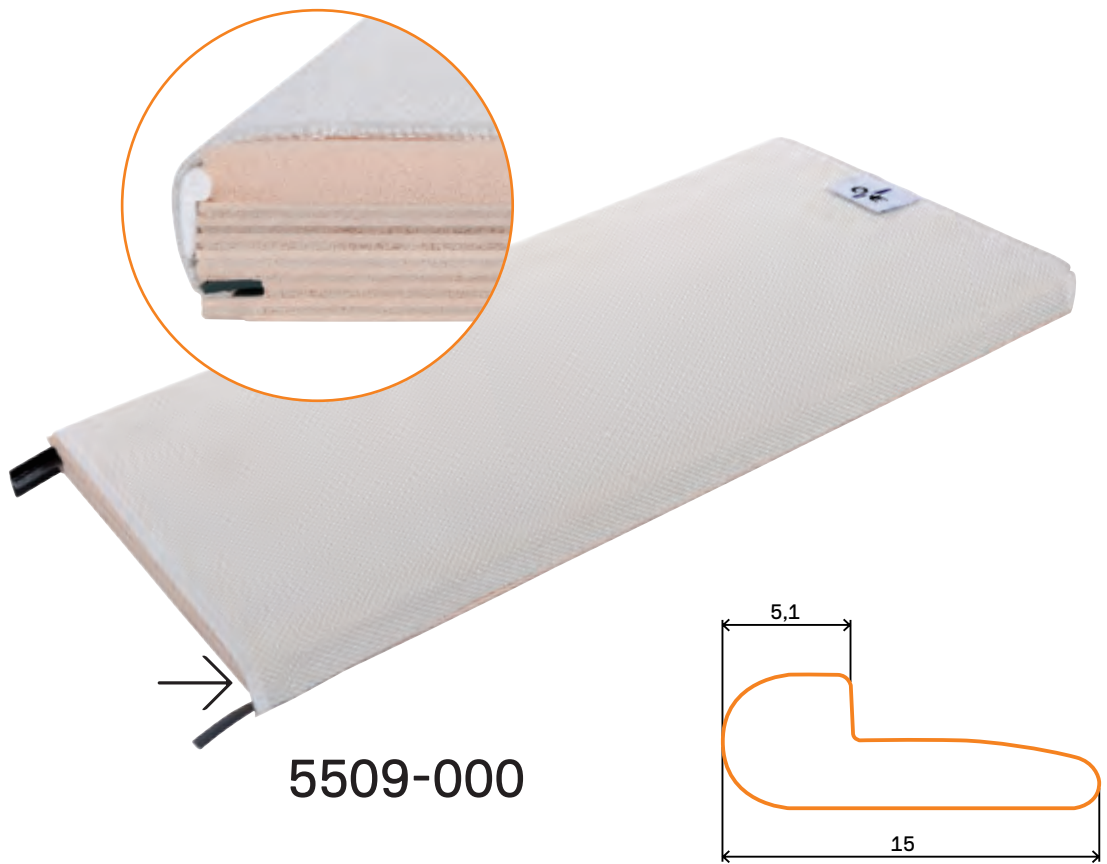

#116 SCHLAUCHKEDER/ EDGE TRIM

NO.	DESCRIPTION	PU	DIMENSIONS
5509-000	mit dezentem Kantenschutz with unobstrusive edge protection	250 Stück 250 pcs.	Länge: 1.200 mm length: 1,200 mm

#117

KOPFTEIL – HEADBOARD

2023-M000
23115-999



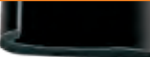

#117 DOPPELVERSCHLUSSSYSTEM/ DOUBLE LOCK SYSTEM

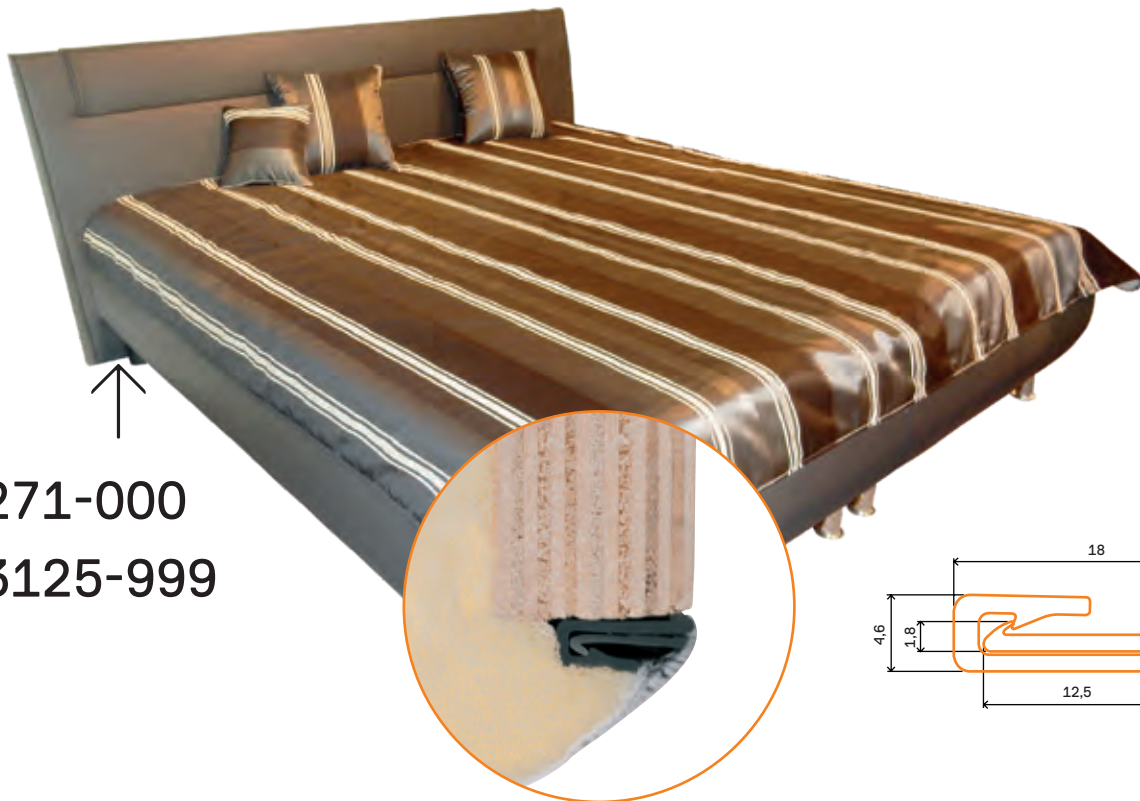
NO.	DESCRIPTION	PU	DIMENSIONS
2023-M000	 Verschlussprofil für zwei Stoffbahnen, ohne Einschnitte lock profile for two fabric panels without cuts	50 Stück 50 pcs.	Länge: 1.200 mm length: 1,200 mm
23115-999	 Gegenleiste counter-bar	Rollen à 500 m rolls at 500 m each	Breite: 11,5 mm width: 11.5 mm



2271-000
23125-999

#118 VERSCHLUSSSYSTEM/ LOCK SYSTEM

NO.	DESCRIPTION	PU	DIMENSIONS
2271-000	 Verschlussprofil mit Widerhaken lock profil with barb	250 Stück 250 pcs.	Länge: 1.200 mm length: 1,200 m
23125-999	 Gegenleiste counter-bar	Rollen à 500 m rolls at 500 m each	Breite: 12,5 mm width: 12.5 mm

#119

KOPFTEIL – HEADBOARD



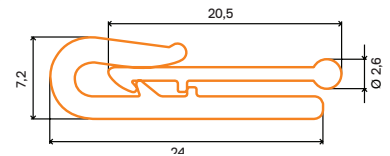

2298-000

2297-000



#119 VERSCHLUSSSYSTEM/ LOCK SYSTEM

NO.	DESCRIPTION	PU	DIMENSIONS
2298-000	 Verschlussprofil mit Widerhaken lock profil with barb	150 Stück 150 pcs.	Länge: 1.200 mm length: 1,200 mm
2297-000	 Gegenleiste mit Kugel counter-bar with ball	300 Stück 300 pcs.	Länge: 1.200 mm length: 1,200 mm

#120 #121

WANGE – SIDEBORD

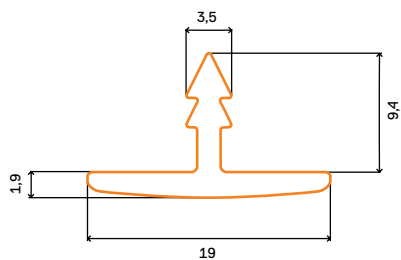

11071-150

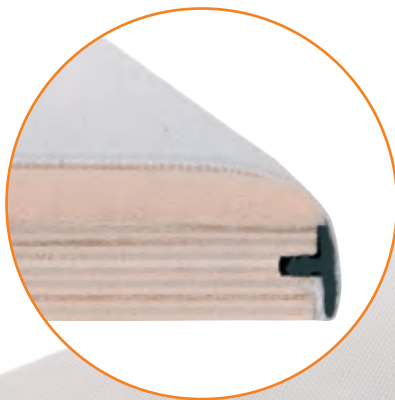

5509-000

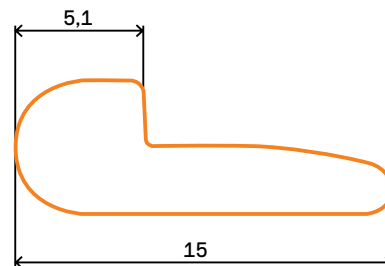

#120 STECKPROFIL/ PLUG-IN PROFILE

NO.	DESCRIPTION	PU	DIMENSIONS
11071-150	mit Oberflächenwölbung für 3 mm Nut with surface curvature for 3 mm groove	100 Stück 100 pcs.	Länge: 1.500 mm length: 1,500 mm



#121 SCHLAUCHKEDER/ EDGE TRIM



NO.	DESCRIPTION	PU	DIMENSIONS
5509-000	mit dezentem Kantenschutz with unobtrusive edge protection	250 Stück 250 pcs.	Länge: 1.200 mm length: 1,200 mm





2040-000
2794

#122 LINIENABHEFTSYSTEM PLEATLINE TUFTING SYSTEM

NO.	DESCRIPTION	PU	DIMENSIONS	FLANGE LENGTH
2040-000	 Führungsschiene mit Fahne guide rail with flange	100 Stück 100 pcs.	Länge: 1.200 mm length: 1,200 m	
2794	 TieDown für besonders schnelle Verarbeitung TieDown for very fast processing	auf Anfrage on request	Stab: 4,0 x 5,1 mm rod: 4.0 x 5.1 mm	15-80 mm 15-80 mm

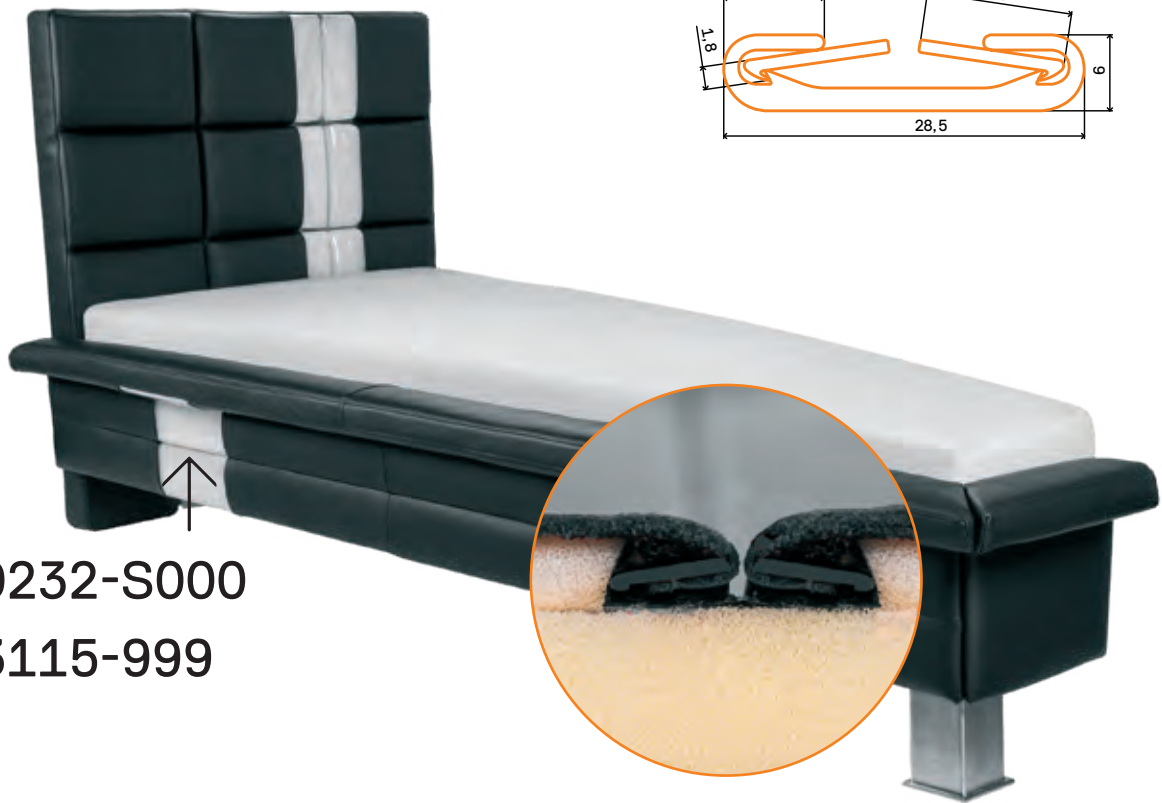

20232-S000

23115-999

#123 DOPPELVERSCHLUSSSYSTEM/ DOUBLE LOCK SYSTEM

NO.	DESCRIPTION	PU	DIMENSIONS
20232-S000	Verschlussprofil für zwei Stoffbahnen, ohne Einschnitte lock profile for two fabric panels without cuts	50 Stück 50 pcs.	Länge: 1.200 mm length: 1.200 mm
23115-999	Gegenleiste counter-bar	Rollen à 500 m rolls at 500 m each	Breite: 11,5 mm width: 11.5 mm

BILDQUELLEN IMPRESSUM/ IMAGE SOURCES IMPRINT

BITTE NOCHMAL ÜBERPRÜFEN,
OB SEITE UND # RICHTIG SIND

76

BÜROSTUHL/
OFFICE CHAIR

→ #78
SEDUS STOLL AG
WWW.SEDUS.DE

80

BÜROSTUHL/
OFFICE CHAIR

→ #79
INTERSTUHL
BÜROMÖBEL
GMBH & CO. KG
WWW.INTERSTUHL.DE

87

BÜROSTUHL/
OFFICE CHAIR

→ #86
SEDUS STOLL AG
WWW.SEDUS.DE

88

BÜROSTUHL/
OFFICE CHAIR

→ #87
SEDUS STOLL AG
WWW.SEDUS.DE

WEITERE BILDQUELLEN/
FURTHER IMAGE SOURCES

→
WWW.SHUTTERSTOCK.DE
WWW.FOTOLIA.DE

AUSGABE



2. AUFLAGE
SEPTEMBER 2021
1.000 EXEMPLARE

HERAUSGEBER



OKE KUNSTSTOFFTECHNIK GMBH & CO. KG
NOBELSTRASSE 7
48477 HÖRSTEL
INFO@OKE.DE
OKE-GROUP.COM

TEXT UND FOTO



OKE KUNSTSTOFFTECHNIK GMBH & CO. KG
NOBELSTRASSE 7
48477 HÖRSTEL
INFO@OKE.DE
OKE-GROUP.COM

COPYRIGHT



© BEI OKE KUNSTSTOFFTECHNIK
GMBH & CO. KG
DAS WERK IST URHEBERRECHTLICH GE-
SCHÜTZT. ZITATE/VERÖFFENTLICHUNGEN
UNTERLIEGEN DEM ZITATRECHT BEI VOLL-
STÄNDIGER QUELLENANGABE.

OKE Kunststofftechnik GmbH & Co. KG
Nobelstraße 7 / 48477 Hörstel / GERMANY

T +49 5459 914-0
info@oke.de

oke-group.com



OKE Kunststofftechnik GmbH & Co. KG
Nobelstraße 7 / 48477 Hörstel / GERMANY

T +49 5459 914-0
info@oke.de

oke-group.com