

C.S. OSBORNE & CO.

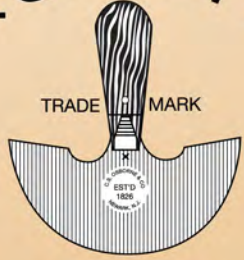

QUALITY



Manufacturing the Finest Leather Tools for the Professional

C. S. OSBORNE & CO.

ESTABLISHED 1826

125 Jersey Street
Harrison, N.J. 07029 - U.S.A.
Fax #(973) 484-3621
E-mail address: cso@csosborne.com
www.csosborneleathertools.com

**TOOLS FOR PROFESSIONAL LEATHERWORK, SADDLERY, LEATHERCRAFT,
THE SHOE INDUSTRY AND VARIOUS CRAFTS**



Since 1826, the Osborne family has dedicated itself to providing the very finest tools. Aply assisted by employees who average over ten years of service to the company, the eighth generation of the Osborne family still manages the firm and continues the tradition requiring strict adherence to the highest standards of quality and service. This dedication continues to provide the best possible hand tools for the professional.

PRICING

All orders are accepted on the basis of price in effect at the time of shipment.

OUR GUARANTEE

We will replace, free of charge, any tool which may prove unsatisfactory in performance if sent for inspection, freight prepaid. Tools which are known to have given reasonable service, or have been misused, or damaged, will not be considered defective.

All orders are accepted on the basis of price in effect at time of shipment

INDEX

Adjustable Gouge	32	Hammers		Nippers, Cutting	51
Arch Punches	6, 7	Hammer, Fitter's	16	Palm, Sewing	54
Awls		Hammer, Glazier	16	Pincers	49
Awl, All Purpose	57	Hammer, Leather working	15	Pins	63
Awl, Automatic	54	Hammer, Magnetic Tack	17, 48	Pliers	
Awl, Badminton	57	Hammer, Riveting	17	Antique Nail	49
Awl, Collar	55	Hammer, Saddler's	15	Cantle	49
Awl, Lacing	55	Hammer, Shoe	15	Canvas or Leather	50
Awl, Moccasin	59	Hammer, Split Head	12	Duckbill	50
Awl, Saddler's	59	Hammer, Wood Heel	17	Eyelet	19
Awl, Scratch	57		28	Lacing	55
Awl, Sewing	59	Hand Press & Dies		Pneumatic Machine	28
Awl, Stabbing	59			Pricking Chisel	38
Awl, Tennis	57	Heel Remover	43	Punches	
Basket Weaving Tools	52	Kits		Punch, Arch	6
Belt Punches	8	Extension Blades w/handle	36	Punch, Arch Sets	7
Blades		Grommet	27	Punch, Bag or Oblong	10, 11
Draw Gauge	44	Needle	66-68	Punch, Belt	8
Extension	36	Snap Set	20	Punch, Custom	11
Gasket Cutter	41	Knives		Punch, Drive	8
Lace Cutter	55	Knife, Bevel Point	34	Punch, Mini-Set	9
Skife	36	Knife, Broad Point	34	Punch, Multi-Use	10
Splitting Machines	44	Knife, Curved Lip Shoe	34	Punch, Oval Drive	10
		Knife, Hawkbill	36	Punch, Pippin	11
Bleeder	41	Knife, Head	35	Punch, Revolving	4, 5
Bone Folders	30	Knife, Incising	38	Punch, Rosette	11
Bracelet Bender	38	Knife, Lead Glass	36	Punch, Self-Centering Sets	9
Caliper, Outside	29	Knife, Leather	35	Punch, Spring	4, 5
Caning Tools	52	Knife, Round	35	Punch, Strap End	10, 11
Chisels		Knife, Seam Ripper	34	Punch, Ventilator	11
Caning	52	Knife, Sharp Point	34		
Pricking	38	Knife, Shoe, Square Point	34	Push Beveler	41
Stitching	37	Knife, Skiving	36	Regulators	63
Thonging	37	Knife, Sloyd	36	Rivets / Setters	18-19
Claw Tools	42	Lace Cutter	55	Rules	
Creasers	32	Lacing Plier	55	Aluminum	53
Cutters		Lasting Pincers	49	Wood	53
Gasket	41	Mallets		Saddlers' Seat Stuffing Steel	32
Grommet Hole	23	Hickory	13	Scratch Compass	29
Lace	55	Hickory Barrel	13	Setters	
Swivel	38	Polymallet	12	Decorative Nail	48
Cutting Nippers	51	Rawhide	12	Eyelet	19
Cutting Pad	9	Rubber	13	Grommet	23, 26
Decorative Nails	45-47	Split Head	12	Rivet	18-19
Design Edge Lifter	41	Mauls		Snaps	20
Dies		Nylon & Rawhide	14	Sewing Palm	54
Grommet Inserting	23, 25	Modelers	39-40	Sharpening Stones	33
Midget Grommet	26	Needle Chart	60	Shears	53
W-1 & W-3 Machines	28	Needles		Sheaths, Leather	35
Divider, Wing	29	Needle, Bent/Straight Pack	65	Skife	36
Draw Gauge	44	Needle, Billards	63	Snaps	20
Edge Tools	31, 32	Needle, Bolster	65	Snap Sets	20
Embossing Wheels/Carriage	41	Needle, Caning	52	Space Marker	41
Extension Blade Handle	36	Needle, Carpet	63	Splitting Machines	44
Eyelet Remover/Setter	19	Needle, Chenille	61	Staple & Tack Removers	43
Eyelet & Rivet Anvil	19	Needle, Collar	62	Stippler	41
Fid	55	Needle, Curved	64	Stitching Chisels	37
Gasket Cutter	41	Needle, Flocking	65	Swivel Cutters	38
Glue Sticks	55	Needle, For Automatic Awl	54	Tacks	48
Grommets	24-26	Needle, Glover's	61	Tack Remover, Shoe	43
Grommet, Hole Cutter	23	Needle, Harness	61	Thread, Waxed	54
Grommet, Home Kit	27	Needle, Kits	66-68	Thread, Waxed Tapered	56
Hafts		Needle, Lacing	55	Thimbles, Open and Closed	54
Awl Haft	58	Needle, Lampshade	64	Thonging Chisels	37
Palm Awl	58	Needle, Mattress	64	Tracers	40
Peg Awl	58	Needle, Pearl Sewing/String.	61	Tuck Wax Iron	32
Sewing	58	Needle, Sailmaker's	65	Ventilator Punch	11
Shoe Awl	58	Needle, Serpentine	62	Wing Dividers	29
		Needle, Spring Eye	65	Zipper Jig	38
		Needle, Smyrna	61	Zipper Pliers	38
		Needle, Straight	65	Zipper Stop Tops	38
		Needle, Loopuyts	62		
		Needle, Tapestry	61		
		Needle, Weaving	62		

All orders are accepted on the basis of price in effect at time of shipment

NUMERICAL INDEX

OSBORNE NO.	PAGE NO.	OSBORNE NO.	PAGE NO.	OSBORNE NO.	PAGE NO.	OSBORNE NO.	PAGE NO.	OSBORNE NO.	PAGE NO.	OSBORNE NO.	PAGE NO.
A1	25	WDIRI41	28	103 ½	55	202	42	458	39	561	61
B1	24	WDIVC1	28	105	11	215	23	459	41	562	61
B1S	25	WDIVC34	28	106	29	216	23	460	36	563	61
B2	24	WDISN201	28	112	29	217	23	464	30	564	61
Custom Punches	11	WDISN41	28	117	30	220-00	5	465	30	565	61
DB1	50	WDISP	26	120 ½	43	222	17	467	39	601	49
DB1-S	50	4	57	121	43	223	5	469	36	602	49
G1	24	6	36	122	42	223T	5	471	39	603	9
G1S	25	7	36	123 ½	42	227	17	472	39	609	38
G2	24	8, 8-B	55	124	42	229	20	473	39	622	11
G3	25	10	49	125	31	230-SET	20	474	40	630	38
K-1	66	12	32	126	31	233	49	475	40	680-685	45-47
K-3	66	18	57	127	31	235	26	476	40	680S-684S	48
K-4	66	20-C	32	127.5-B	31	236	17	477	55	689	48
K-5	67	21	32	127.5-S	31	237	17	478	57	700	37
K-6	67	24-24	19	128	32	238	17	479	34	701	40
K-7	66	31	59	129	43	245	8	481	37	702	40
K-8	67	32	59	130	32	245MM	8	483	37	704	40
K-10	68	36	48	133-B	31	248	5	484	37	708	53
K-11	68	34	29	133-S	31	249	50	485	41	727	30
K-12	68	38-C	29	139	11	250	50	488	41	727A	30
K-14	7	40-52	59	140	57	251	50	487	38	741	64
K-14MM	7	50	41	140-A	59	256	19	491-498	37	777	48
K-15	68	51 ½	44	140-H	58	257	19	496	12	791	43
K-16	7	54-59	59	141	58	259	36	500	23	797	43
K-156	9	55	15	142	58	266	54	501	64	799	43
K-157	9	57	17	143	58	299N	51	501 ½	64	802	53
K229	20	60SE	53	144	58	299PG	51	501X	64	925	36
K230	20	62	17	145	58	301	51	502	64	925-D	36
K231	27	63	59	147	8	306 ½	63	502 ½	64	925-100	36
K232	27	64	59	149	6	322	49	502X	64	928	58
K233	27	65	15	149MM	6	392	14	503	64	1000	55
K234	27	66	15	0150	10	393	14	504	65	1003	55
K235	27	67	35	150	10	395	12	505	65	1012	38
K-245	9	68	32	151	10	396	13	506	65	1013	38
K245-L	9	70	35	152	10	400	11	507	65	1014	38
K257	26	71	35	153	4	405	52	508	65	1020	34
K-460	36	72	35	153T	4	406	52	508-½ SE	65	1021	33
K-500	23	73	36	154	11	407	52	509	65	1023	33
K4708	21	74	35	155	4	409	64	510	54	1024	33
K4713	21	75	35	155-A	4	411 ½	55	511	54	1025	33
K4717	21	76	34	155T	4	413	54	513	64	1026	33
K6708	21	76 ½	34	158	10	421	55	513X	64	1028	33
M32	59	77	34	160	53	421-L	55	514	65	1066 B	16
M34	59	78	34	161	53	423	52	515	63	1700	18
Needle Chart	60	78 ½	34	164	53	423-L	52	516	63	1999	16
N1	24	79 ½	34	167	19	424-B	52	517	61	2000	55
N1S	25	80	51	168	19	424-S	52	518	61	2003	55
N2	24	81	34	169	18	425	36	519	62	2999	16
N3	25	84	44	170	18	433-436	56	520	63	3377	51
Snaps	21-22	86	44	181	63	443	19	521-40MM	63	4712	22
SS	24	86-A	44	189	63	444	38	523	62	4802	48
SS1S	25	89.5	13	190	63	446	38	524	62	52247	62
T-10	57	90	13	190S	63	447	41	553	64	52248	62
T-11	57	91	51	193	63	448	41	554	65	6860-7266	45-47
W-1	28	92 ½	62	196	12	452	37	555	65		
W-3	28	93	49	197	13	453	19	556	65		
W8BLT	53	94	51	198	63	454	39	557	65		
W-50	26	98	50	200	42	456	19	559-5	61		
WDIGRC	28	98-S	50	201	42	457	41	560	61		



REVOLVING PUNCH - for professional and industrial use

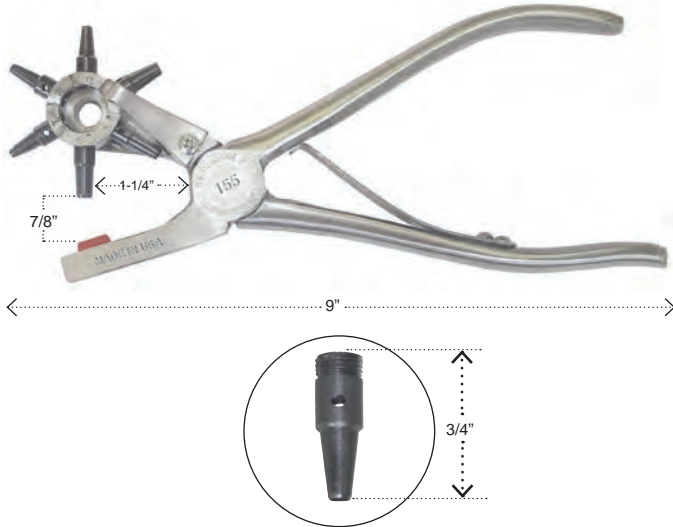

Replacement punch tube

Osborne No. 155 0-7

Six tube punch made with tubes 0, 1, 2, 3, 5 & 7. This punch is known as the best Revolving Punch made. The frame is made of forged steel, highly polished. Cutting tubes are turned from special carbon tool steel and threaded to allow easy replacement. Each tube is individually hardened. The throat distance from the cutting tube to the back of jaw is 1 1/2". Weight each is 14 oz.

Osborne No.	Description	UPC No.
155 0-7	Revolving punch	52012
155-A	Extra anvil	52052
155-HS	Extra handle spring	02070
155-SP	Extra side spring	02072
155T-(size)	Extra tubes	-----
155T 0-7	Set of replacement tubes	02044

Note: Numbers 155, 153 and 223 tubes are not interchangeable. No. 155 punch takes tubes up to size 6 and 7 only as indicated on the cylinder of the punch. Punch tubes measure 3/4" overall.

SPRING PUNCH - for professional and industrial use



Replacement punch tube

Osborne No. 153

Forged steel frame. Highly polished. Fitted with replaceable screw tubes. The reach or distance from the cutting tube to the back of jaw is 1 1/2". Made in sizes 000 to 10. Weight each 14 oz.

Osborne No.	Description	UPC No.	Osborne No.	Description	UPC No.
153-000	Spring punch	52110	153-6	Spring punch	52126
153-00	Spring punch	52112	153-7	Spring punch	52128
153-0	Spring punch	52114	153-8	Spring punch	52130
153-1	Spring punch	52116	153-9	Spring punch	52132
153-2	Spring punch	52118	153-10	Spring punch	52134
153-3	Spring punch	52120	153-A	Extra anvil	52050
153-4	Spring punch	52122	153-HS	Handle spring	02182
153-5	Spring punch	52124	153T-(sz)	Extra tubes	Below

Note: There are three different frames. Tubes sizes 000 to 7 fit the same frame and are interchangeable. Tube 8 fits No. 8 frame only. Tubes 9 and 10 fit the same frame and are interchangeable. Punch tubes measure 1-1/8" overall.

ACTUAL SIZES OF CUTTING TUBES FOR OSBORNE NOS. 153 AND 155 PUNCHES

	52150	52152	52154	52156	52158	52160	52162	52164	52166	52168	52170	52172	52174
153 Tubes UPC No.	52150	52152	52154	52156	52158	52160	52162	52164	52166	52168	52170	52172	52174
155 Tubes UPC No.	-	52022	52024	52026	52028	52030	52032	52034	52036	52038	-	-	-
Actual Size	●	●	●	●	●	●	●	●	●	●	●	●	●
Size No.	000	00	0	1	2	3	4	5	6	7	8	9	10
Diameter Size	3/64	1/16	5/64	3/32	7/64	1/8	5/32	11/64	3/16	13/64	1/4	9/32	5/16



REVOLVING PUNCH - Nickel Plated



PACKED ON A DISPLAY CARD 11" x 4".

Osborne No. 223

A fine quality pressed steel frame revolving punch with drive tubes. All tubes are heat treated to give long wear. Furnished with tubes sizes: 0 (5/64"), 1 (3/32"), 2 (7/64"), 3 (1/8"), 4 (5/32") & 6 (3/16").

Osborne No.	Description	Weight ea. (oz.)	UPC No.
223	Revolving Punch	6	02290
223T-0	Replacement tube 5/64"	1	52222
223T-1	Replacement tube 3/32"	1	52224
223T-2	Replacement tube 7/64"	1	52226
223T-3	Replacement tube 1/8"	1	52228
223T-4	Replacement tube 5/32"	1	52230
223T-6	Replacement tube 3/16"	1	52234

SPRING PUNCH - Zinc plated



Osborne No. 220-00

A sturdy pressed steel punch with replaceable drive tubes. Non-removable anvil. Frame furnished with size 00 tube.

Osborne No.	Length (inches)	Throat depth (inches)	Weight each (oz)	UPC No.
220-00	8	1 1/4	7	52260

Extra tubes	00	0	1	2	3	4	5	6	7
UPC No.	52220	52222	52224	52226	52228	52230	52232	52234	52236

SPRING PUNCH - Zinc plated



Osborne No. 248

A sturdy pressed steel punch with easily replaceable tubes. Compact, ruggedly constructed. Fits any hand comfortably.

Osborne No.	Length (inches)	Throat depth (inches)	Weight each (oz)	UPC No.
248-00	6	3/4	4	52270
248-0				52272

Extra tubes	00	0	1	2	3	4
UPC No.	02276	02278	02280	02282	02284	02286

OSBORNE



ARCH PUNCHES

These punches should be used on a wood or plastic cutting block or the Osborne No. #603 Cutting pad. The use of an Osborne wooden or rawhide mallet or rawhide maul is recommended. Steel hammers are not recommended.

ARCH PUNCH - Original and correct design for cutting

Osborne No. 149



Osborne arch punches are drop forged in one piece from the finest special carbon steel in sizes from 1/8" to 2 1/8" diameter. Larger sizes are made with our properly engineered two piece welded construction. A unique feature of the Osborne arch punch is the inside taper which permits the punchings to clear easily through the barrel. Punches have fully polished barrel.

The cutting edge is fully hardened all the way through and properly finished to provide long use trouble free punching. There is no other Hollow Punch that can compare.

Meets Government Standards

Diameter (inches)	Weight ea (lbs) (oz)	UPC No.	Diameter (inches)	Weight ea (lbs) (oz)	UPC No.	Diameter (inches)	Weight ea (lbs) (oz)	UPC No.	Diameter (inches)	Weight ea (lbs) (oz)	UPC No.	Diameter (inches)	Weight ea (lbs) (oz)	UPC No.
1/8	- 2	01008	1 1/2	2 -	01052	2 7/8	1 15	01096	4 1/4	5 -	01140	5 5/8	5 14	01172
3/16	- 2	01010	1 9/16	1 14	01054	2 15/16	2 11	01098	4 5/16	5 -	01142	5 11/16	5 14	01173
1/4	- 2	01012	1 5/8	1 14	01056	3	2 12	01100	4 3/8	5 1	01144	5 3/4	5 14	01174
5/16	- 2	01014	1 11/16	1 8	01058	3 1/16	2 5	01102	4 7/16	5 1	01146	5 13/16	5 15	01175
3/8	- 3	01016	1 3/4	2 6	01060	3 1/8	2 9	01104	4 1/2	5 1	01148	5 7/8	5 15	01176
7/16	- 5	01018	1 13/16	2 5	01062	3 3/16	2 13	01106	4 9/16	5 2	01150	5 15/16	6 -	01177
1/2	- 7	01020	1 7/8	2 4	01064	3 1/4	2 11	01108	4 5/8	5 4	01152	6	6 -	01178
9/16	- 7	01022	1 15/16	2 2	01066	3 5/16	5 4	01110	4 11/16	5 4	01154	6 1/16	6 -	01179
5/8	- 8	01024	2	3 13	01068	3 3/8	4 11	01112	4 3/4	5 5	01156	6 1/8	6 1	01185
11/16	- 8	01026	2 1/16	3 8	01070	3 7/16	4 11	01114	4 13/16	5 6	01158	6 3/16	6 1	01186
3/4	- 9	01028	2 1/8	3 13	01072	3 1/2	4 12	01116	4 7/8	5 6	01160	6 1/4	6 2	01187
13/16	- 8	01030	2 3/16	1 10	01074	3 9/16	2 5	01118	4 15/16	5 7	01161	6 5/16	6 2	01188
7/8	- 12	01032	2 1/4	2 7	01076	3 5/8	3 13	01120	5	5 8	01162	6 3/8	6 3	01189
15/16	- 12	01034	2 5/16	2 7	01078	3 11/16	3 15	01122	5 1/16	5 8	01163	6 7/16	6 3	01190
1	- 13	01036	2 3/8	2 8	01080	3 3/4	4 8	01124	5 1/8	5 10	01164	6 1/2	6 3	01191
1 1/16	- 12	01038	2 7/16	2 8	01082	3 13/16	3 12	01126	5 3/16	5 10	01165	6 9/16	6 4	01192
1 1/8	- 15	01040	2 1/2	2 10	01084	3 7/8	4 2	01128	5 1/4	5 11	01166	6 5/8	6 4	01193
1 3/16	- 15	01042	2 9/16	2 14	01086	3 15/16	3 12	01130	5 5/16	5 11	01167	6 11/16	6 4	01194
1 1/4	1 3	01044	2 5/8	2 15	01088	4	4 12	01132	5 3/8	5 12	01168	6 3/4	6 5	01195
1 5/16	1 5	01046	2 11/16	2 15	01090	4 1/16	4 5	01134	5 7/16	5 12	01169	6 13/16	6 5	01196
1 3/8	1 9	01048	2 3/4	3 1	01092	4 1/8	3 14	01136	5 1/2	5 13	01170	6 7/8	6 5	01197
1 7/16	1 9	01050	2 13/16	2 8	01094	4 3/16	4 6	01138	5 9/16	5 13	01171	7	6 6	01199

Metric stock sizes shown below:

Diameter (mm)	Weight ea (lbs) (oz)	UPC No.	Diameter (mm)	Weight ea (lbs) (oz)	UPC No.	Diameter (mm)	Weight ea (lbs) (oz)	UPC No.	Diameter (mm)	Weight ea (lbs) (oz)	UPC No.	Diameter (mm)	Weight ea (lbs) (oz)	UPC No.
2	- 3	01204	14	- 6	01228	26	1 -	01252	38	2 -	01276	50	3 12	01300
3	- 3	01206	15	- 8	01230	27	1 -	01254	39	2 -	01278	51	4 -	01302
4	- 3	01208	16	- 8	01232	28	1 2	01256	40	1 13	01280	52	4 -	01304
5	- 3	01210	17	- 9	01234	29	1 2	01258	41	2 12	01282	53	4 -	01306
6	- 3	01212	18	- 9	01236	30	1 2	01260	42	2 12	01284	54	4 8	01308
7	- 3	01214	19	- 11	01238	31	1 6	01262	43	3 -	01286	55	4 8	01310
8	- 3	01216	20	- 10	01240	32	1 4	01264	44	3 -	01288	56	4 12	01312
9	- 5	01218	21	- 12	01242	33	1 6	01266	45	3 -	01290	57	4 12	01314
10	- 5	01220	22	- 12	01244	34	1 6	01268	46	3 -	01292	58	5 -	01316
11	- 5	01222	23	- 12	01246	35	1 8	01270	47	3 8	01294	59	5 -	01318
12	- 5	01224	24	1 -	01248	36	1 10	01272	48	3 8	01296	60	5 -	01320
13	- 6	01226	25	1 -	01250	37	1 8	01274	49	3 12	01298			



These punches should be used on a wood or plastic cutting block or the Osborne No. #603 Cutting pad. The use of an Osborne wooden or rawhide mallet or rawhide maul is recommended. Steel hammers are not recommended.

ARCH PUNCH SETS

Osborne No. K-14

This set of seven arch punches includes the sizes most widely used. They are put up in a sturdy, easy to use canvas tool roll as shown.



1 each of following sizes Osborne No. 149 - Arch Punch:									Weight per set (lbs)	UPC No.
K-14	Sizes (inches)	1/4	3/8	1/2	5/8	3/4	7/8	1	4	01180

Osborne No. K-14MM

This set of seven arch punches includes the most popular millimeter sizes. They are put up in a sturdy, easy to use canvas tool roll as shown.



1 each of following sizes Osborne No. 149 - Arch Punch:									Weight per set (lbs)	UPC No.
K-14MM	Sizes (mm)	6	8	10	12	16	20	25	2 1/2	01179

Osborne No. K-16

This set of seven arch punches of sixteenth sizes are incremented by 1/8" starting with 3/16". They are put up in a sturdy, easy to use canvas tool roll as shown.



1 each of following sizes Osborne No. 149 - Arch Punch:									Weight per set (lbs)	UPC No.
K-16	Sizes (inches)	3/16	5/16	7/16	9/16	11/16	13/16	15/16	4	01181

OSBORNE



PUNCHES

These punches should be used on a wood or plastic cutting block or the Osborne No. #603 Cutting pad. The use of an Osborne wooden or rawhide mallet or rawhide maul is recommended. Steel hammers are not recommended.

ROUND OR DRIVE PUNCH

Osborne No. 147



These Drive or Saddlers' Punches are **drop forged** from finest special carbon steel, carefully hardened, with polished barrel. The hole tapers back from the cutting edge so that the punchings clear freely and require only a light blow with a mallet to cut with ease.

Actual Size																	
Size No.	0	1	2	3	4	5	6	7	8	9	10	11	12	13	14	15	16
Diameter Size	5/64	7/64	1/8	9/64	5/32	11/64	3/16	7/32	1/4	9/32	5/16	3/8	13/32	7/16	15/32	33/64	9/16
Weight ea (oz)	2	2	2	2	2	2	2	3	3	3	3	4	4	6	6	7	9
UPC No.	51410	51412	51414	51416	51418	51420	51422	51424	51426	51428	51430	51432	51434	51436	51438	51440	51442

BELT PUNCH - Round shank

Osborne No. 245

Hardened cutting edge - milled clearing hole. Available in imperial and metric sizes.

Inches



Size No.	00	0	1	2	3	4	5	6	7	8	9	10	11	12	13	14
Actual size																
Diameter (inches)	1/16	5/64	3/32	1/8	9/64	5/32	11/64	3/16	13/64	7/32	1/4	17/64	9/32	5/16	11/32	3/8
Weight (oz)	1	1	1	1	1	1	1	1	1	1	1	3	3	3	4	4
UPC No.	51460	51462	51464	51666	51468	51470	51472	51474	51476	51478	51480	51482	51484	51486	51488	51490

Size No.	15	16	1/2	9/16	5/8	3/4	13/16	7/8	22
Actual size									
Diameter (inches)	13/32	7/16	1/2	9/16	5/8	3/4	13/16	7/8	1
Weight (oz)	4	4	7	9	9	12	13	13	15
UPC No.	51492	51494	51496	51500	51498	51536	51538	51540	51542

Metric

Actual size											
Diameter (mm)	2	3	4	5	6	7	8	9	10	11	12
Weight (oz)	1	1	1	1	1	1	1	1	1	1	1
UPC No.	51502	51504	51506	51508	51510	51512	51514	51516	51518	51520	51522
Actual size											
Diameter (mm)	13	14	15	16	18	20					
UPC No.	51524	51526	51528	51530	51534	51538					



These punches should be used on a wood or plastic cutting block or the Osborne No. #603 Cutting pad. The use of an Osborne wooden or rawhide mallet or rawhide maul is recommended. Steel hammers are not recommended.

Osborne No. K-245

BELT PUNCH SETS

Osborne No. K-245 L



Kit contains 1 each of Belt punches in the following sizes: 1/8", 5/32", 3/16" 1/4" , 5/16" and 3/8".
Punches are packed in a sturdy plastic pouch.
Weight per set: 13 oz.
UPC No. 01520



Kit contains 1 each of Belt punches in the following sizes: 1/2", 9/16", 5/8", 3/4", 7/8" and 1". Punches are packed in a canvas tool roll. Weight per set: 4 lb. 12 oz. UPC No. 01524.

MINI-PUNCH SET

Osborne No. K-157



A special punch set for cutting small, precise holes in soft materials where throated or plier punches won't reach. Set has a round handle with slot inside to clear punchings. Handle is threaded to accommodate the seven replaceable screw tubes sizes which are shown below. See page 4 at bottom for actual sizes of cutting tubes. Set consists of seven tubes and handle. Sets is carded for display purposes. **REPLACEMENT TUBES** are also sold individually Osborne No. 153T. Specify size when ordering.

Tube size No.	0	1	2	3	4	5	6	Weight per set (oz)	UPC No.
Tube size (inches)	5/64	3/32	7/64	1/8	5/32	11/64	3/16	8	01860

SELF-CENTERING PUNCH SET

Osborne No. K-156



This handy and versatile kit contains threaded handle with self-centering pointed plunger. The threaded handle will accommodate nine inter-changeable threaded cutting tubes. The punches in this set will cleanly cut leather, rubber, paper, plastics and other soft materials. The self-centering point makes these punches ideal for cutting concentric washers in small quantities by hand. Sizes of punches listed below. All cutting edges properly hardened. The only professional tool like it. Comes in a sturdy plastic box for storage.

Tube sizes (inches)	Weight per set (lbs)	UPC No.
1/4 5/16 3/8 7/16 1/2 5/8 3/4 7/8 1	2 1/4	01870

REPLACEMENT PARTS			
K156-H	Extra handle	K-156T 1/2	Extra tube
K-156T 1/4	Extra tube	K-156T 5/8	Extra tube
K-156T 5/16	Extra tube	K-156T 3/4	Extra tube
K-156T 3/8	Extra tube	K-156T-7/8	Extra tube
K-156T 7/16	Extra tube	K-156T 1	Extra tube

CUTTING PAD

Osborne No. 603



Made of a special formula resilient vinyl plastic, these tough cutting pads are ideal for use with Osborne Punches. They are long wearing and can be used on both sides. Cutting pads should be used on a solid base for best results. The self-healing surface absorbs cuts and helps prevent scars from forming on the smooth face of the pad.

Size (inches)	Weight ea (lbs) (oz)	UPC No.
10 x 10 x 3/8	2 4	67692



OSBORNE

PUNCHES

These punches should be used on a wood cutting block or Osborne No. #603 Cutting pad. The use of an Osborne wooden or rawhide mallet or maul is recommended. Steel hammers are not recommended. Every Osborne edge is hand file sharpened and is true.

STRAP END PUNCH



STRAP END PUNCH - English point



Hardened and polished edges.

Size (inches)	1/4	3/8	1/2	5/8	3/4	7/8	1	
Weight ea (oz)	2	3	4	4	5	6	7	
150 UPC No.	01710	01712	01714	01716	01718	01720	01722	
0150 UPC No.	01670	01672	01674	01676	01678	01680	01682	
Size (inches)	1 1/8	1 1/4	1 3/8	1 1/2	1 5/8	1 3/4	1 7/8	2
Weight ea (oz)	7	8	9	9	9	10	14	16
150 UPC No.	01724	01726	01728	01730	01732	01734	01735	01736
0150 UPC No.	01684	01686	01688	01690	01691	01692	01693	01694

MULTI-USE STRAP END PUNCH



Osborne No. 152

Cuts a clean end on belts and straps. Hardened and polished edge. Cuts up to 2" width.

Weight ea (oz)	UPC No.
12	01796

BAG OR OBLONG PUNCH



Osborne No. 151

Bag or Oblong punches. Taper clearance. Polished barrel, hardened and polished edge. Used extensively by leather bag and strap manufacturers.

OVAL DRIVE PUNCH



Osborne No. 158

Like our other punches, No. 158 is made of the best grade of alloy steel, carefully tempered with polished edge. The hole tapers back from the cutting edge so that punchings can clear freely. Polished barrel. Made in sizes 1 to 16 as shown below.

Size No.	Dimension (inches)	UPC No.	Size No.	Dimension (inches)	UPC No.	Size No.	Dimension (inches)	UPC No.	Size No.	Dimension (inches)	UPC No.
1	1/8 x 3/32	01812	5	7/32 x 5/32	01820	9	11/32 x 7/32	01828	13	17/32 x 11/32	01836
2	5/32 x 7/64	01814	6	1/4 x 5/32	01822	10	3/8 x 1/4	01830	14	9/16 x 3/8	01838
3	3/16 x 1/8	01816	7	9/32 x 6/32	01824	11	7/16 x 5/16	01832	15	19/32 x 7/16	01840
4	6/32 x 1/8	01818	8	5/16 x 7/32	01826	12	1/2 x 5/16	01834	16	5/8 x 7/16	01842

Actual size

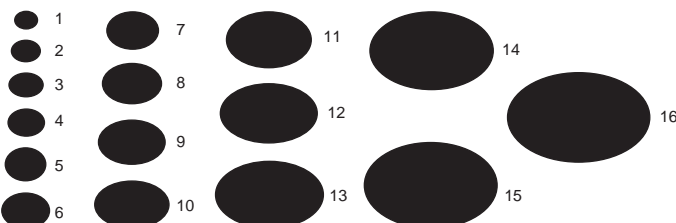

Actual size	Length (inches)	Width (inches)	Wt. ea (oz)	UPC No.
	1/4	5/64	3	01760
	3/8	3/32	4	01762
	1/2	7/64	4	01764
	5/8	1/8	5	01766
	3/4	9/64	5	01768
	7/8	5/32	7	01770
	1	5/32	7	01772
	1 1/8	11/64	9	01774
	1 1/4	11/64	9	01776
	1 3/8	3/16	10	01778
	1 1/2	13/64	13	01780
	1 5/8	7/32	13	01782
	1 3/4	7/32	13	01784
	1 7/8	1/4	16	01786
	2	1/4	22	01788

OSBORNE



PUNCHES

PIPPIN PUNCHES - Drop forged. Highly polished. Hardened edges.

Osborne No. 105-1 (Round punch)



Size No.	Overall length (inches)	Overall cut (inches)	Length of cut (inches)	Diameter of hole (inches)	Weight ea. (oz)	UPC No.
1	4 3/8	7/8	5/8	1/8	2	51051
2				1/8 x (3/16 long)		51052

Osborne No. 105-2 (Oval punch)



ROSETTE CUTTER

Osborne No. 139

Polished and hardened edges.



Size No.	Weight ea (oz)	Overall length (inches)	UPC No.
1	10 1/2	6	01390
1 1/4	11	6	01392
1 1/2	12 1/2	6 1/8	01394
1 3/4	14	6 1/2	01396
2	16	6 1/2	01398
2 1/4	17	6 1/2	01389
2 1/2	18	6 1/2	01400



Cutters are also available without handles.

STRAP END PUNCH

Osborne No. 154

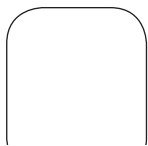

Size No.	Weight ea (oz)	Overall length (inches)	UPC No.
1	10 1/2	6 1/8	01702
1 1/2	12 1/2	6 1/8	01704
1 3/4	14	6 1/2	01706
2	16	7	01708
2 1/2	18	7	01711

CUSTOM SHAPE PUNCHES

MOUND TOOL COMPANY



For punches in special shapes, designs and sizes, please contact the above company.
 An affiliate of C. S. Osborne & Co., Mound Tool Co. is located at 9301 Watson Ind. Park. St. Louis, MO 63126, USA.
 Their telephone number is 1-314-968-3991, fax number is 1-314-968-1240.
 E-mail address: info@moundtool.com

VENTILATOR PUNCH

Osborne No. 622



Used to punch ventilator holes in leather, vinyl, etc. with holes illustrated in the pattern insert. Uses Osborne No. 248T-2 tubes.

Overall Length (inch)	Holes diameter (inch)	Weight ea (oz)	UPC No.
5 1/4	3/32	10	02198

OBLONG PUNCH

Osborne No. 400



Polished barrel with hardened cutting edge. Hole tapers inside for easy punching clearings.

Size No.	Size (inches)	Weight ea (oz)	UPC No.
1	11/16 x 3/16	5	01644
2	7/8 x 1/4	6	01646



SPLIT HEAD HAMMER

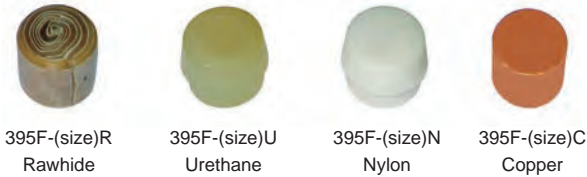
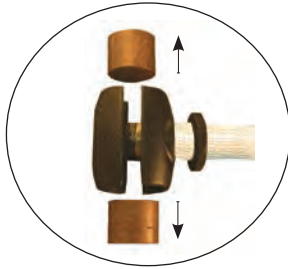

Osborne No. 395

Ideal for use with punches, grommet dies and wherever a cushioned blow is desired. No trouble to replace faces. Just loosen the safety nut, remove the worn face, insert replacement and tighten. Long wearing. Rawhide, nylon, urethane and copper faces available. Rawhide faces supplied if none is specified.

Osborne No.	Description	Weight pair (lbs)	(oz)	Diameter of face (inches)	Length of head (inches)	UPC No.
395-1R	Sz. 1 - Rawhide	1	9	1 1/4	3 5/8	11090
395-2R	Sz. 2 - Rawhide	2	-	1 1/2	4 1/4	11094
395-3R	Sz. 3 - Rawhide	2	15	1 3/4	4 7/8	11098
395-1N	Sz. 1 - Nylon	1	8	1 1/4	3 5/8	11092
395-2N	Sz. 2 - Nylon	2	-	1 1/2	4 1/4	11096
395-3N	Sz. 3 - Nylon	2	15	1 3/4	4 7/8	11100
395-1U	Sz. 1 - Urethane	1	8	1 1/4	3 5/8	11091
395-2U	Sz. 2 - Urethane	2	-	1 1/2	4 1/4	11095
395-3U	Sz. 3 - Urethane	2	15	1 3/4	4 7/8	11099
395-1C	Sz. 1 - Copper	2	-	1 1/4	3 5/8	11093
395-2C	Sz. 2 - Copper	2	15	1 1/2	4 1/4	11097
395-3C	Sz. 3 - Copper	4	4	1 3/4	4 7/8	11101

REPLACEMENT FACES

Osborne No.	UPC No.	Osborne No.	UPC No.	Osborne No.	UPC No.	Osborne No.	UPC No.
395F-1R	11103	395F-1N	11105	395F-1U	11104	395F-1C	11106
395F-2R	11107	395F-2N	11109	395F-2U	11108	395F-2C	11110
395F-3R	11111	395F-3N	11113	395F-3U	11112	395F-3C	11114

RAWHIDE MALLET - With solid head



Osborne No. 196

The head of this light-weight mallet is made entirely of rolled water buffalo rawhide. Handle is white hickory. It is recommended for many jobs where the user wishes to avoid scarring.

Size No.	Length of head (inches)	Diameter of face (inches)	Length of handle (in)	Weight each (oz)	UPC No.
0	2 3/8	1	9	2	11052
1	3 1/8	1 1/4	9	4	11054
2	3 1/4	1 1/2	9 1/4	6	11056
3	3 3/8	1 3/4	10 1/4	8	11058
4	3 1/2	2	10 1/4	10	11060
5	4	2 1/2	11 1/4	16	11062
6	4 1/2	2 3/4	11 1/4	20	11064

POLY MALLET



Osborne No. 496

The strong polymer head is wear resistant and long lasting. The special material absorbs shock and minimizes the mallet bouncing back. Hardwood handle. Ideal for use with our Osborne No. K-157 Mini Punch Set and Osborne thonging chisels. Also used for hammering leather seams and leather tooling.

Length of head (inches)	Diameter of face (inches)	Length of handle (inches)	Weight each (oz)	UPC No.
3 1/2	1 3/4	10	8	11082



BARREL SHAPED HICKORY MALLET



All hickory lacquered.

Osborne No. 89.5

Made of hickory, a carefully finished, well balanced, lacquered solid mallet.

Size No.	Diameter of face (inches)	Diameter of head (inches)	Length of handle (inches)	Weight ea (oz)	UPC No.
2 1/2	2 3/8	5 1/2	10 1/2	16	61014
3	2 1/4	5 1/2	10 1/4	12	61016
3 1/2	2	5 1/4	10 1/4	12	61018
4	1 3/4	5	10 1/4	8	61020

HICKORY MALLET



All hickory lacquered.

Osborne No. 90

A serviceable and sturdy mallet, widely used for a variety of purposes.

Size No.	Diameter of face (inches)	Diameter of head (inches)	Length of handle (inches)	Weight ea (oz)	UPC No.
2	2 3/4	5 1/2	10 1/2	18	61032
3	2 1/2	5 1/2	10 1/2	17	61034
4	2	5	10 1/2	14	61036
5	2	4	9	8	61038

BLACK RUBBER MALLET



Osborne No. 197

Rubber mallets can be used without fear of marring metal parts. Limited bounce. Head of solid dense black rubber with white hardwood handle.

Size No.	Diameter of face (inches)	Length of head (inches)	Overall length (inches)	Weight ea (oz)	UPC No.
2	2	3 1/4	12	11	61162
3	2 1/2	4 1/2	14	24	61164

WHITE RUBBER MALLET



Osborne No. 396

Extra heavy white rubber mallet will not mar surface. Superior quality. Finest on the market. Limited bounce. White hardwood handle.

Size No.	Diameter of face (inches)	Length of head (inches)	Overall length (inches)	Weight ea (oz)	UPC No.
2	2	3 1/4	12	13	61142
3	2 1/2	4 1/2	14	28	61146



RAWHIDE MAULS

Osborne No. 393

Well balanced and built to last. The water buffalo hides are uniquely treated for maximum durability and shock absorbance. Easy to handle, they strike square and deliver controlled dead blows. Used with tarp & sail making, tool & die shops, leather crafting, cutting dies, etc. The laminated heads are specially compressed between 2 brass flanges, connected to a lacquered oak handle by an internal solid steel rod. Available in 6 sizes.

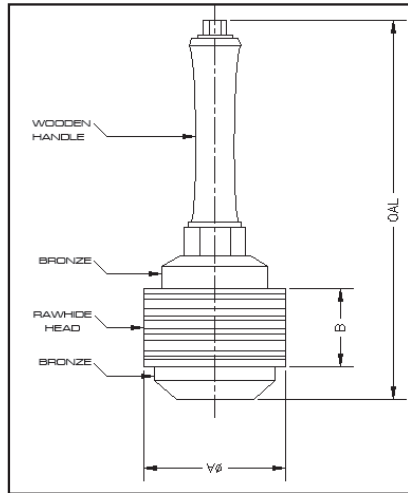

Replacement parts and rawhide refills are also available.

Osborne No.	Approximate Weight	Head Diameter "A"	Head Length "B"	Overall Length "OAL"	UPC No.
393-1-1/2	1-1/2 lbs.	2-1/2"	1-5/8"	8-3/4"	11008
393-2	2 lbs.	2-3/4"	1-5/8"	8-3/4"	11020
393-3	3 lbs.	3"	1-3/4"	9-1/4"	11022
393-4	4 lbs.	3-5/8"	2-1/4"	10"	11024
393-6	6 lbs.	4"	2-1/4"	10-3/4"	11026
393-8	8 lbs.	4-1/4"	2-1/4"	11"	11028

RAWHIDE REFILLS

Osborne No.	Description	UPC No.
393-1-1/2 RR	Rawhide refill for # 1-1/2 Maul	11006
393-2 RR	Rawhide refill for # 2 Maul	11030
393-3 RR	Rawhide refill for # 3 Maul	11032
393-4 RR	Rawhide refill for # 4 Maul	11034
393-6 RR	Rawhide refill for # 6 Maul	11036
393-8 RR	Rawhide refill for # 8 Maul	11038

NYLON MAULS

Osborne No. 392

Similar in construction and specs to above rawhide mauls but fitted with nylon head.

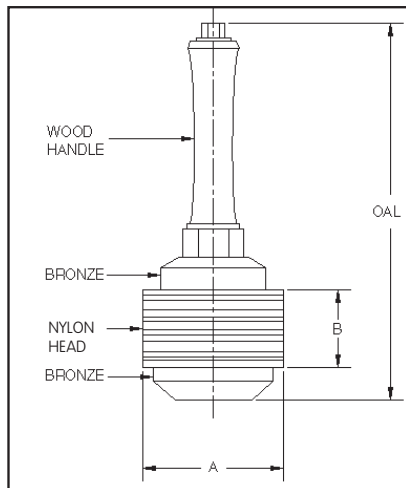

Replacement parts and nylon refills are also available.

Osborne No.	Approximate Weight	Head Diameter "A"	Head Length "B"	Overall Length "OAL"	UPC No.
392-1-1/2	1-1/2 lbs.	2-1/2"	1-5/8"	8-3/4"	11000
392-2	2 lbs.	2-3/4"	1-5/8"	8-3/4"	11001
392-3	3 lbs.	3"	1-3/4"	9-1/4"	11002
392-4	4 lbs.	3-5/8"	2-1/4"	10"	11003
392-6	6 lbs.	4"	2-1/4"	10-3/4"	11004
392-8	8 lbs.	4-1/4"	2-1/4"	11"	11005

NYLON REFILLS

Osborne No.	Description	UPC No.
392-1-1/2 NR	Nylon refill for # 1-1/2 Maul	11073
392-2 NR	Nylon refill for # 2 Maul	11074
392-3 NR	Nylon refill for # 3 Maul	11075
392-4 NR	Nylon refill for # 4 Maul	11076
392-6 NR	Nylon refill for # 6 Maul	11077
392-8 NR	Nylon refill for # 8 Maul	11078



SHOE HAMMER



Osborne No. 65

The popular standard type Shoe Hammer. Drop forged steel. Highly polished head. Indispensable in leatherwork. Most useful for making sharp folds, adhering cemented parts together, tapping over hand stitches, lacing, welts, etc.

Length of head (inches)	Diameter of face (inches)	Length of handle (inches)	Weight ea (oz)	UPC No.
5 5/8	1 1/4	9 1/2	14	56124

LEATHER WORKING HAMMER



Osborne No. 66

Popular with the pocket book, belt, shoe, luggage, saddlers and the small leather goods industry. Drop forged steel. Rounded, polished face to prevent marring of leather. Hickory handle.

Length of head (inches)	Diameter of face (inches)	Length of handle (inches)	Weight ea (oz)	UPC No.
3 1/4	1 5/16	8 1/4	14	56126

SADDLER'S HAMMER



Osborne No. 55

French Saddler's Hammer, oval Walnut Handle riveted through the steel shank. Head and handle are steel, forged in one piece, highly polished. The smooth, blunt end of the hammer is ideal to form leather and drive tacks in hard to reach places.

Length of head (inches)	Diameter of face (inches)	Length of handle (inches)	Weight ea (oz)	UPC No.
7	1/2	10 1/4	16	56142

○ Round face



FITTERS' HAMMER



Osborne No. 1999

Used for pounding seams and smoothing leather. Polished face. Made of malleable iron.

Face diameter (inches)	Overall (inches)	Weight ea. (oz)	UPC No.
1-5/16	4-5/8	11	56008

LARGE FITTERS' HAMMER



Osborne No. 2999

Manufactured of malleable iron. Fully nickel plated. Smooth face. Used for pounding seams and smoothing leather.

Large Face diameter (inches)	Small Face diameter (inches)	Overall (inches)	Weight ea. (lb) (oz)	UPC No.
3	1-5/8	5	2 2	56010

GLAZIER & PICTURE FRAME HAMMER



Osborne No. 1066 B

Hardwood handle. Forged steel head fully polished. An industry standard. Accurately finished sides and face for square striking.

Length of head (inches)	Face diameter (inches)	Overall length (inches)	Weight ea (oz)	UPC No.
4-1/4"	11/16	12"	6	70042

Square face



Osborne magnetic hammers will give long service if properly used and stored. The magnetic end must be used only for setting a tack in place. The striking end is for driving tacks home. The magnetic head should never be left in contact with other steel objects. Should one of our hammers lose its magnetism, we will recharge free it if sent prepaid to the factory.

WOOD HEEL HAMMER



C.S. OSBORNE & CO. No. 227

○ Round face

Osborne No. 227

Forged steel, fully polished. Used by saddlers, luggage manufacturers and by the pocket book trade. Fully polished head. Claw on one end.

Length of head (inches)	Diameter of face(inches)	Weight ea (oz)	UPC No.
6 3/8	7/16	10	56132

MAGNETIC TACK HAMMERS



C.S. OSBORNE & CO. No. 236

Osborne Nos. 236, 237 & 238

Popular weights and sizes. Forged steel, carefully hardened. Fully polished split head. Best quality hickory handle. Made to U.S. Government specifications.

Osborne No.	Length of head (in)	Weight of head (oz)	Magnetic face (in)	Overall length (in)	Weight ea (oz)	UPC No.
236	3 1/2	4	1/4	11	6	56032
237	4 1/8	5	1/4	11	7	56034
238	4 3/8	7	5/16	10 1/2	11	56036

POPULAR MAGNETIC TACK HAMMER

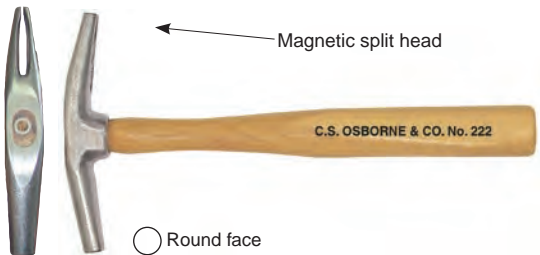

C.S. OSBORNE & CO. No. 222

← Magnetic split head

○ Round face

Osborne No. 222

Forged steel. Fully polished split head. Hickory handle. A versatile hammer used in many leather trades. Made to U.S. Government specifications.

Length of head (inches)	Weight of head (oz)	Magnetic face(inches)	Large face (inches)	Weight ea (oz)	UPC No.
5 1/2	7	5/16	9/16	13	56012

RIVETING HAMMER



C.S. OSBORNE & CO. No. 57

Osborne No. 57

Drop forged steel, highly polished head. Hickory handle.

Size No.	Length of head (inches)	Diameter of face (inches)	Weight of head (oz)	Weight each (oz)	UPC No.
000	3	3/8	2 1/2	4	56082
00	3 3/8	3/8	3	4	56084
0	3 5/8	7/16	4	6	56086
1	4	1/2	5	8	56088
2	4 1/4	9/16	7	12	56090
3	4 1/2	5/8	9	14	56092
4	4 3/4	3/4	12	16	56094

RIVETING HAMMER - Octagon head pattern



C.S. OSBORNE & CO. No. 62

○ Octagon face

Osborne No. 62

Standard size 3 Riveting Hammer. Drop forged from fine quality alloy steel. Hardened with polished face and pein.

Length of head (inches)	Face (inches)	Weight of head (oz)	Length of handle (inches)	Weight ea (lbs)	UPC No.
4 7/8	1	12	12	1	56112



COPPER RIVETS

Osborne No. 1700

Copper rivets and burrs. Use with Osborne Nos. 169 & 170. Packed 1 lb. per box.



Size number	8	9	10	12	14
Diameter under head (inches)	.181	.161	.151	.137	.102
Overall length (inches)	3/4	3/4	3/4	3/4	3/4
Approx. number of rivets & burrs per lb.	100	125	152	186	314
Tool to be used	170-8	170-9	170-10	169-6	169-8
UPC No.	67278	67279	67280	67282	67284

RIVET SETTERS

Osborne No. 170

Drop forged, polished face. 3 sizes available.

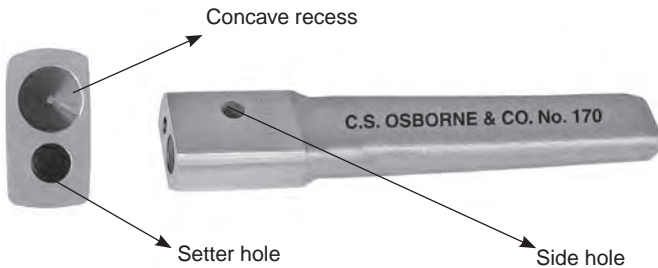

Osborne No.	Hole Dia.	Copper Rivet	Rivet Shank Dia.	Weight ea (oz)	UPC No.
170-8	.191	8	.181	5	67252
170-9	.171	9	.161	5	67254
170-10	.161	10	.151	5	67256

Osborne No. 169

Polished face, forged steel. Hardened working end. Sets solid copper or iron rivets. For proper installation, choose a tool with a setter hole diameter slightly larger than the rivet being set. Use the side hole to dislodge metal slugs. Variety of sizes.

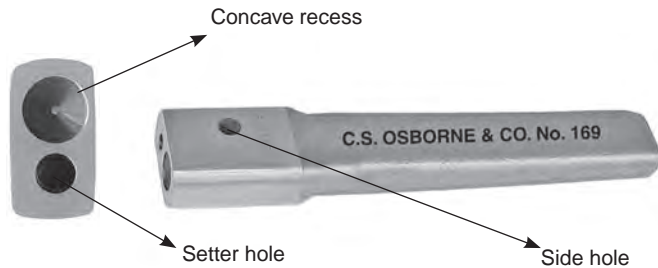

Osborne No.	Hole Diameter (inches)	Copper Rivet	Iron Rivet	Weight ea. (oz)	UPC No.
169-00	5/16	-	14	15	67222
169-0	9/32	10, 12	10, 12	15	67224
169-1	15/64	6	6	9	67226
169-2	.213	7	7	9	67228
169-3	.191	4, 5	4, 5	9	67230
169-4	.166	9	2-1/2, 3	9	67232
169-5	.149	10, 11	1-3/4, 2	5	67234
169-6	9/64	12	1-1/2	5	67236
169-7	1/8	13	1-1/4	5	67238
169-8	7/64	14	10, 12	5	67240

Instructions

Choose the setter with a hole diameter slightly larger than the rivet being set. Sizes for #170 correspond with popular 8, 9 and 10 copper rivets. For other size rivets, use table below to determine proper size of #169 Rivet Setter. Push the rivet through the hole then turn the material over. Place burr on rivet, then use the rivet setting tool's straight hole to drive the burr down tight against the material. Cut the rivet off close to the burr with side or end nippers. Do not cut off flush with the burr, but leave about 1/16 of an inch above the burr. The hole on the side of the rivet setter can be used to dislodge any waste that is wedged into the tool. Place the concave recess of setter on the burr. Hold perpendicular and strike the tool forcefully, turning to the left then right as you strike. This spreads the end of the rivet over the burr, simultaneously rounding its end. A few extra blows from the soft faced mallet can be used to flatten the rivet end a bit, if desired.



RIVET SETTER



Osborne No. 443

For use with loose leaf binders. Made of high quality steel. Polished end.

Overall length (inches)	Shank diameter (inches)	Weight ea. (oz.)	UPC No.
4	3/8	2	67352

RIVET SETTER



Osborne No. 168

Rivet setter with concave end and knurled handle.

Overall length (inches)	Shank diameter (inches)	Weight ea. (oz.)	UPC No.
4	3/8	2	67220

EYELET SETTER



Osborne No. 456

Spreads eyelets so that they can be flattened with a mallet or rawhide hammer. Knurled handle prevents slipping. Nickel plated.

Overall length (inches)	Shank diameter (inches)	Weight ea. (oz.)	UPC No.
4 3/8	5/16	1	67402

EYELET SETTER



Osborne No. 24-24

Spreads eyelets so that they can be flattened with a mallet or rawhide hammer. Knurled handle prevents slipping. Nickel plated.

Overall length (inches)	Shank diameter (inches)	Weight ea. (oz.)	UPC No.
4 3/8	1/4	1	67400

EYELET SETTER

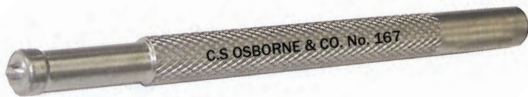

Osborne No. 167

Knurled handle prevents slipping. Nickel plated. Available in sizes 1/8" and 3/16". Specify when ordering.

Overall length (inches)	Shank diameter (inches)	Weight ea. (oz.)	UPC No.
4 3/8	1/8	2	67406
4 3/8	3/16	2	67408

EYELET & RIVET ANVIL



Osborne No. 453

Concave anvil. Used to support eyelets and rivets when being set. UPC No. 67403.

COMBINATION EYELET SETTER

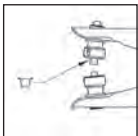

Osborne No. 257

In addition to its excellent attributes for leather and parchment work, this tool has become highly popular for industrial use. Enables eyelets to be set in paper card and other materials. Pierces material and sets 3/16" and 1/8" eyelets with a single action. Please specify size when ordering.

Osborne No.	Sets eyelet	Throat depth (inches)	Weight ea. (oz.)	UPC No.
257 5/32	3/16	1-1/4	7	17292
257 1/4	1/8			17293

EYELET REMOVER - Nickel plated



Osborne No. 256

A sturdy pressed steel eyelet remover pliers. Compact, ruggedly constructed. Fits hand comfortably.

Length (inches)	Throat depth (inches)	Weight ea. (oz.)	UPC No.
7 3/4	1 1/4	7	17290



SNAP FASTENER KIT - With snaps



**Osborne No. K229-20 (Baby Snaps)
Osborne No. K229-24 (Standard Snaps)**

Includes parts to complete six 5/8" standard nickel plated brass snaps or 1/2" baby snaps along with flaring tool and die. Comes with instructions on back of hang up card 4 3/4" x 5 3/4".

Osborne No.	Description	Peso (oz.)	UPC No.
K229-20	Snap Kit for baby snaps # 20	3	14230
K229-24	Snap Kit for standard snaps # 24	3	14232

DURABLE SNAP SETTER



Osborne No. 229

Osborne No. 229-20 - Setting die for #20 Baby Dot snaps.
Osborne No. 229-24 - Setting die for #24 Standard snaps.
Comes with flaring tool and a double-sided die.

Osborne No.	Description	Weight ea. (oz.)	UPC No.
229-20	Snap Kit for baby snaps # 20	2	14236
229-24	Snap Kit for standard snaps # 24	2	14234

SNAP FASTENER KIT - With snaps



Osborne No. K230

An easy to use hand snap set. Snaps are nickel plated brass. Available in standard 5/8" snaps and 1/2" baby snaps. Set comes with 25 complete snaps, flaring tool and two dies (concave and stud).

Osborne No.	Description	UPC No.
K230-20	# 20 Snap set kit	14231
K230-24	# 24 Snap set kit	14228

SNAP SETTER



Osborne No. 230-SET 20 & 230-SET 24

3 pc. setter only. No snaps are included. Available for line # 20 (1/2" baby snaps) and line # 24 (standard 5/8" snaps).

Osborne No.	Description	Weight ea. (oz.)	UPC No.
230-SET 20	# 20 snap setter only	2	14236
230-SET 24	# 24 snap setter only	2	14234



SNAPS FASTENERS

1/4" high
Also available
in 3/8"



1/4" high
Also available
in 3/8"

MATERIAL	Brass	Steel	Stainless Steel		
FINISHES	Nickel plated	Enamel black	Shiny brass	Copper black	Antique
SIZES	# 20 (BABY SNAPS 1/2") & # 24 (STANDARD SNAPS 5/8")				
QUANTITY	100 pcs per box = C or 1,000 pcs. per box = M				

**SOLD PER SETS
OR BY INDIVIDUAL
PARTS**

SETS (COMPLETE 4 PARTS)

OSBORNE No.	Size	Material	Finish	Pcs.	UPC No.	
K1708-11-C	20	STAINLESS STEEL	STAINLESS STEEL	100	14196	
K1708-11-M				1,000	14198	
K2708-11-C		BRASS	NICKEL PLATED	100	14200	
K2708-11-M				1,000	14202	
K2713-16-C			COPPER BLACK	100	14204	
K2713-16-M				1,000	14206	
K2717-20-C		SHINY BRASS	100	14208		
K2717-20-M			1,000	14210		
K3708-11-C		STEEL	NICKEL PLATED	100	14212	
K3708-11-M				1,000	14214	
K3713-16-C			COPPER BLACK	100	14216	
K3713-16-M				1,000	14218	
K3717-20-C			SHINY BRASS	100	14220	
K3717-20-M				1,000	14222	
K3721-24-C			ANTIQUE	100	14256	
K3721-24-M				1,000	14258	
K4708-11-C			BRASS	NICKEL PLATED	100	14235
K4708-11-M					1,000	14237
K4908-11-C		NICKEL PLATED XL Cap & Eyelet		100	14243	
K4908-11-M				1,000	14246	
K4713-16-C	COPPER BLACK	100		14238		
K4713-16-M		1,000		14239		
K4717-20-C	SHINY BRASS	100		14240		
K4717-20-M		1,000		14241		
K4721-24-C	STEEL	ANTIQUE		100	14252	
K4721-24-M				1,000	14254	
K5708-11-C	STEEL	NICKEL PLATED		100	14245	
K5708-11-M				1,000	14247	
K5713-16-C		COPPER BLACK		100	14248	
K5713-16-M				1,000	14249	
K5717-20-C		SHINY BRASS	100	14250		
K5717-20-M			1,000	14251		
K6708-11-C	STAINLESS STEEL	STAINLESS STEEL	100	14260		
K6708-11-M			1,000	14262		

INDIVIDUAL PARTS

OSBORNE No.	Size	Part	Material	Finish	Pcs.	UPC No.			
1708-C	20	Eyelet	STAINLESS STEEL	STAINLESS STEEL	100	67286			
1708-M					1,000	67288			
1709-C		Cap			100	67290			
1709-M					1,000	67292			
1710-C		Socket			100	67294			
1710-M					1,000	67296			
1711-C		Stud			100	67298			
1711-M					1,000	67300			
2708-C		20			Eyelet	BRASS	NICKEL PLATED	100	40002
2708-M								1,000	40004
2709-C	Cap		100	40008					
2709-M			1,000	40010					
2710-C	Socket		100	40014					
2710-M			1,000	40016					
2711-C	Stud		100	40020					
2711-M			1,000	40022					
2713-C	20		Eyelet	BRASS	COPPER BLACK			100	40026
2713-M								1,000	40028
2714-C		Cap	100			40032			
2714-M			1,000			40034			
2715-C		Socket	100			40038			
2715-M			1,000			40040			
2716-C		Stud	100			40044			
2716-M			1,000			40046			
2717-C		20	Eyelet			BRASS	SHINY BRASS	100	40050
2717-M								1,000	40052
2718-C	Cap		100	40056					
2718-M			1,000	40058					
2719-C	Socket		100	40062					
2719-M			1,000	40064					
2720-C	Stud	100	40068						
2720-M		1,000	40070						
2721-C	20	Eyelet	BRASS	ANTIQUE	100	50000			
2721-M					1,000	50002			
2722-C		Cap			100	50004			
2722-M					1,000	50006			
2723-C		Socket			100	50008			
2723-M					1,000	50010			
2724-C		Stud			100	50012			
2724-M					1,000	50014			
3708-C		20			Eyelet	STEEL	NICKEL PLATED	100	40074
3708-M								1,000	40076
3709-C	Cap		100	40080					
3709-M			1,000	40082					
3710-C	Socket		100	40086					
3710-M			1,000	40088					
3711-C	Stud		100	40092					
3711-M			1,000	40094					



OSBORNE No.	Size	Part	Material	Finish	Pcs.	UPC No.	
3713-C	20	Eyelet	STEEL	COPPER BLACK	100	40098	
3713-M					1,000	40100	
3714-C		Cap			100	40104	
3714-M					1,000	40106	
3715-C		Socket			100	40110	
3715-M					1,000	40112	
3716-C		Stud			100	40116	
3716-M					1,000	40118	
3717-C	20	Eyelet	STEEL	SHINY BRASS	100	40122	
3717-M					1,000	40124	
3718-C		Cap			100	40128	
3718-M					1,000	40130	
3719-C		Socket			100	40134	
3719-M					1,000	40136	
3720-C		Stud			100	40140	
3720-M					1,000	40142	
4708-C	24	Eyelet	BRASS	NICKEL PLATED	100	78368	
4708-M					1,000	78372	
4709-C		Cap			100	78380	
4709-M					1,000	78384	
4710-C		Socket			100	78392	
4710-M					1,000	78396	
4711-C		Stud			100	78356	
4711-M					1,000	78360	
4713-C	24	Eyelet	BRASS	COPPER BLACK	100	78428	
4713-M					1,000	78432	
4714-C		Cap			100	40152	
4714-M					1,000	40154	
4715-C		Socket			100	40158	
4715-M					1,000	40159	
4716-C		Stud			100	40162	
4716-M					1,000	40164	
4717-C	24	Eyelet	BRASS	SHINY BRASS	100	40168	
4717-M					1,000	40170	
4718-C		Cap			100	40174	
4718-M					1,000	40176	
4719-C		Socket			100	40180	
4719-M					1,000	40182	
4720-C		Stud			100	40186	
4720-M					1,000	40188	
4725-C	24	Eyelet	BRASS	ANTIQUUE	100	50016	
4725-M					1,000	50018	
4726-C		Cap			100	50020	
4726-M					1,000	50022	
4727-C		Socket			100	50024	
4727-M					1,000	50026	
4728-C		Stud			100	50028	
4728-M					1,000	50030	
4908-C	24	Eyelet XL 3/8"	BRASS	NICKEL P.	100	40198	
4908-M					1,000	40200	
4909-C		Cap XL 3/8"			100	40204	
4909-M	1,000		40206				
5708-C	24	Eyelet	STEEL	NICKEL PLATED	100	78584	
5708-M					1,000	78588	
5709-C		Cap			100	78596	
5709-M					1,000	75600	
5710-C		Socket			100	78608	
5710-M					1,000	78612	
5711-C		Stud			100	78620	
5711-M					1,000	78624	
5713-C	24	Eyelet	STEEL	COPPER BLACK	100	40222	
5713-M					1,000	40224	
5714-BLK C		Cap		ENAMEL BLACK	100	40225	
5714-BLK M					1,000	40227	
5714-C		Cap		COPPER BLACK	100	40228	
5714-M					1,000	40230	
5715-C		Socket			100	40234	
5715-M					1,000	40236	
5716-C	Stud	100	40240				
5716-M		1,000	40242				
5717-C	24	Eyelet	STEEL		SHINY BRASS	100	40246
5717-M						1,000	40248
5718-C		Cap		100		40252	
5718-M				1,000		40254	
5719-C		Socket		100		40258	
5719-M				1,000		40260	
5720-C		Stud		100		40264	
5720-M				1,000		40266	
6708-C	24	Eyelet	STAINLESS STEEL	STAINLESS STEEL	100	40300	
6708-M					1,000	40302	
6709-C		Cap			100	40304	
6709-M					1,000	40306	
6710-C		Socket			100	40308	
6710-M					1,000	40310	
6711-C		Stud			100	40312	
6711-M					1,000	40314	

SCREW STUD



Osborne No.	Description	UPC No.
4712-3/8C	Br. Screw stud 3/8" pk. 100	78404
4712-3/8M	Br. Screw stud 3/8" pk. 1000	78400
4712-5/8C	Br. Screw stud 5/8" pk. 100	78416
4712-5/8M	Br. Screw stud 5/8" pk. 1000	78420
4712SS-3/8C	SS. Screw stud 3/8" pk. 100	78410
4712SS-3/8M	SS. Screw stud 3/8" pk. 1000	78416
4712SS-5/8C	SS. Screw stud 5/8" pk. 100	78412
4712SS-5/8M	SS. Screw stud 5/8" pk. 1000	78414

Used on furniture, automobiles, recreational vehicles, manufactured housing, etc. It snaps into a nylon snap ring and shell after it's fully assembled or into a socket and cap.

MATERIAL	Brass	Stainless Steel
FINISHES	Nickel plated	Stainless Steel
SIZES	3/8" long and 5/8" long.	
QUANTITY	100 pcs per box = C or 1,000 pcs. per box = M	



OSBORNE

GROMMETS DIES & CUTTER

Osborne grommet inserting dies and grommet hole cutters are numbered to correspond with standard size grommets. The dies are guaranteed to set the proper size and style Osborne grommets. Grommet dies and cutters should be used with an Osborne rawhide hammer or wooden mallet, not with a steel hammer. We recommend our No. 395 rawhide hammers for this purpose.

PLAIN GROMMET INSERTING DIES



Male sits flat on base.

Osborne No. 216

Sets **plain rim grommets and washers**. Sizes 00 thru 5 are CNC machined from high grade tool steel, while sizes 6 & up are a malleable iron casting. Properly machined and hardened. The finest industrial grommet dies made. For best results use only Osborne grommets and washers G1, B1, N1.

Size No.	Weight each (lbs)	(oz)	UPC No.	Size No.	Weight each (lbs)	(oz)	UPC No.
00	1	6	13212	5	2	10	13224
0	1	6	13214	6	3	15	13226
1	1	7	13216	8	3	16	13230
2	1	7	13218	10	3	10	13232
3	1	9	13220	11	4	15	13234
4	2	8	13222	15	5	15	13236

Osborne No. 215

These dies look similar to above but are engineered from a **high carbon steel tough enough to set stainless steel grommets** Osborne No. SS. Available for grommet sizes: 00 (3/16"), 0 (1/4"), 1 (9/32"), 2 (3/8"), 3 (7/16") and size 4 (1/2").

SPUR GROMMET INSERTING DIE



Male sits higher on base. This gap prevents teeth on spur grommets from getting crushed when set.

Osborne No. 217

Sets **rolled rim grommets & spur washers**. Sizes 0 thru 5 CNC machined from high grade tool steel, while sizes 6 & up are a malleable iron casting. Properly machined and hardened. The finest industrial grommet dies made. For best results use only Osborne grommets and washers G2, N2 & B2 with corresponding sizes.

Size No.	Weight each (lbs)	(oz)	UPC No.	Size No.	Weight each (lbs)	(oz)	UPC No.
0	1	6	13244	5	2	10	13254
1	1	7	13246	6	3	15	13256
2	1	7	13248	7	4	6	13258
3	1	9	13250	8	5	8	13260
4	2	8	13252	10	7	8	13262

GROMMET HOLE CUTTER



Osborne No. 500

Use with corresponding sizes of grommets and setting dies. Drop forged, hardened and polished edge. Inside tapered for easy clearance.

Size No.	Hole size (in)	Weight ea. (oz.)	UPC No.	Size No.	Hole size (in)	Weight ea. (oz.)	UPC No.
00A	3/16	2	51610	4A	1/2	6	51620
0A	1/4	2	51612	5A	5/8	9	51622
1A	9/32	3	51614	6A	3/4	9	51624
2A	3/8	3	51616	7A	7/8	12	51626
3A	7/16	6	51618	8A	1	13	51628

GROMMET HOLE CUTTER SET



Osborne No. K-500

Packed in a vinyl pouch and contains 1 each of sizes: 3/16", 1/4", 9/32", 3/8", 7/16" and 1/2". UPC No. 01522.

Osborne No.	Hole punch sizes included (inches)						Weight (lb)	(oz)
K-500	3/16	1/4	9/32	3/8	7/16	1/2	1	8



OSBORNE

GROMMETS

For best results in setting our plain rim grommets and washers, use an **Osborne No. 500** hole punch and an **Osborne No. 216** setting die with corresponding sizes. Also can be set using W-1 & W-3 Machines. Sizes 00 to 6 are packed in 1 gross boxes.

PLAIN RIM GROMMETS AND WASHERS

Osborne No. G1 & N1 & B1

Sizes 00 to 6 available in BRASS, NICKEL & DULL BLACK finish. Material is brass. 144 pcs. per box.

Osborne No. SS

STAINLESS STEEL. Sizes 00 to 4 available. 144 pcs. per box.

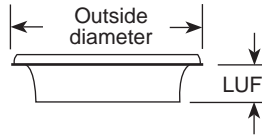

G1 - BRASS



N1 - NICKEL



B1 - DULL BLACK



SS - STAINLESS STEEL

Size No.	Diameter of hole when set (inches)	Outside diameter (inches)	Length under flange (inches)	Weight/box (lbs) (oz)	BRASS UPC No.	NICKEL UPC No.	BLACK UPC No.	STAINLESS UPC No.
00	3/16	0.460	0.135	- 2	13012	13112	71884	72880
0	1/4	0.546	0.175	- 5	13014	13114	71882	72882
1	9/32	0.700	0.185	- 8	13016	13116	71886	72884
2	3/8	0.835	0.215	- 12	13018	13118	71888	72886
3	7/16	0.955	0.295	1 2	13020	13120	71890	72888
4	1/2	1.062	0.374	1 8	13022	13122	71892	72890
5	5/8	1.205	0.330	1 12	13024	13124	71894	N/A
6	13/16	1.828	0.232	6 -	13026	13126	71896	N/A

For best results in setting our ROLLED rim grommets and SPUR washers, use an **Osborne No. 500** hole punch and an **Osborne No. 217** setting die with corresponding sizes. Also can be set using W-1 & W-3 Machines. Sizes 00 to 6 are packed in 1 gross boxes.

ROLLED RIM GROMMETS AND SPUR WASHERS

Osborne No. G2, N2 & B2

Sizes 0 to 8 available in BRASS, NICKEL and DULL BLACK finish. Material is brass. 144 pcs. per box.



G2 - BRASS



N2 - NICKEL



B2 - DULL BLACK

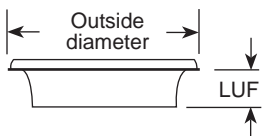

Size No.	Diameter of hole when set (inches)	Outside diameter (inches)	Length under flange (inches)	Weight/box (lbs) (oz)	BRASS UPC No.	NICKEL UPC No.	BLACK UPC No.
0	9/32	0.645	0.175	- 13	13044	13144	13344
1	13/32	0.790	0.205	1 2	13046	13146	13346
2	7/16	0.890	0.215	1 10	13048	13148	13348
3	15/32	0.970	0.255	2 4	13050	13150	13350
4	9/16	1.120	0.320	2 4	13052	13152	13352
5	5/8	1.270	0.380	3 8	13054	13154	N/A
6	3/4	1.505	0.420	5 10	13056	13156	N/A
7	29/32	1.725	0.446	5 10	13058	13158	N/A
8	1 3/32	1.910	0.465	8 2	13060	13160	N/A



SELF PIERCING GROMMETS & WASHERS

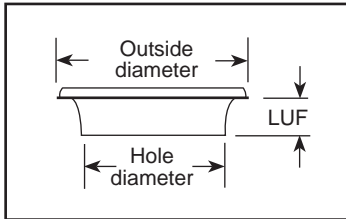

Osborne No. G3 & N3

Made of heavier gauge brass compared to traditional sheet metal grommets.

Pierce and set in a single action. No need to prepunch the hole.

These grommets are install only using our Hand Press Machine Osborne No. W-1 or our W-3 Pneumatic Machine using the appropriated dies (page 26).

Available in 4 sizes with BRASS or NICKEL finish.

Packed and sold in 500 pcs. per box.

Osborne No.	Finish	Hole Diameter (in)	Outside Diameter (in)	L.U.F. (in)	UPC No.
G3-0	Brass	1/4	0.550	0.165	13064
G3-1	Brass	5/16	0.630	0.200	13066
G3-2	Brass	3/8	0.750	0.320	13068
G3-3	Brass	7/16	0.970	0.185	13070
N3-0	Nickel	1/4	0.550	0.165	13164
N3-1	Nickel	5/16	0.630	0.200	13166
N3-2	Nickel	3/8	0.750	0.320	13168
N3-3	Nickel	7/16	0.970	0.185	13170

These **LARGE GROMMETS** are installed with our Osborne No. W-1 Hand Press Machine or W-3 Pneumatic Machine using their correspondent grommet dies. Available in 3 sizes. Packed and sold in boxes of 20 sets. Size 10 is SPUR, 12 & 15 are PLAIN.



* G2-10 & N2-10 are spur
LUF = Length under flange

Osborne No.	Finish	Whole diameter (inches)	Outside diameter (inches)	LUF (inches)	Weight/box (lbs) (oz)	UPC No.
G2-10	* BRASS	1-1/2	2.36	0.355	1 - 3	13062
N2-10	* NICKEL					13162
A1-12	ANTIQUE	1-9/16	2.453	0.360	1 - 5	71878
B1-12	BLACK					71880
G1-12	BRASS					71874
N1-12	NICKEL					71876
A1-15	ANTIQUE	2	3.135	0.420	1 - 6	71879
B1-15	BLACK					71881
G1-15	BRASS					71872
N1-15	NICKEL					71877

GROMMETS REFILLS

Osborne No. G1S, N1S, B1S & SS1S

Plain rim grommets refills for our Grommet Kits Osborne No. K235 & K232. Available in **BRASS** finish Osborne No. G1S, **NICKEL** finish Osborne No. N1S, **DULL BLACK** finish Osborne No. B1S, and **STAINLESS STEEL** Osborne No. SS1S. Packaged in hang up display bags.



No. G1S



No. N1S



No. B1S



No. SS1S

Size No.	Grommets per bag	G1S UPC No.	N1S UPC No.	B1S UPC No.	SS1S UPC No.
00	24	12998	13005	71862	81860
0	24	13000	13032	71860	81862
1	24	13001	13006	71864	81864
2	24	13002	13007	71866	81866
3	24	13003	13008	71868	81878
4	24	13004	13009	71870	81870

SOLD BY BOXES ONLY (6 BAGS PER BOX)



OSBORNE

GROMMET SETTERS

SELF PIERCING GROMMET DIES

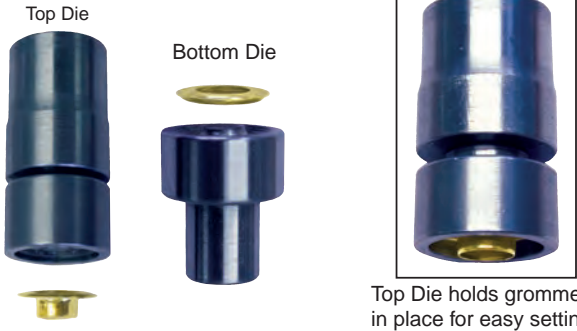

Top Die holds grommet in place for easy setting.

Made from high quality steel and CNC machined. Blued finish to help prevent corrosion. 2 pc. set. No cutter needed. Top die retains grommet from falling when been set. 4 sizes available. These setting dies work with our Osborne No. W-1 Hand Press or Osborne No. W-3 Pneumatic Press.

Osborne No.	Description	UPC No.
WDISP0	Self piercing setting die set for 1/4" grommet	75862
WDISP1	Self piercing setting die set for 5/16" grommet	75863
WDISP2	Self piercing setting die set for 3/8" grommet	75864
WDISP3	Self piercing setting die set for 7/16" grommet	75865

PRESS-IT'S SET - Portable Snap & Grommet Setter

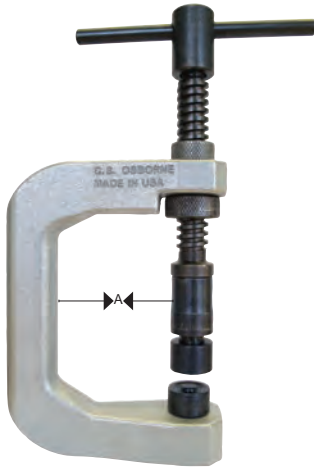

Osborne No. W50

Made of light weight aluminum construction. Easy to use and carry. Sets snaps, grommets. No need for table or hammer to set. Screw action. It works with self piercing grommet dies, regular dies and snaps dies which are sold separately. (not included). It can set up to size # 4 grommets with ease.

Overall height (inches)	Distance A (inches)	Weight (lbs.) (oz.)	UPC No.
11	2-1/2	2 8	76286

MIDGET GROMMET DIE



Osborne No. 235

For setting plain rim washers and grommets. For home use or hobbyist.

Size No.	Weight ea. lbs.	UPC No.	Size No.	Weight ea. lbs.	UPC No.
00	1	13272	3	1 1/4	13280
0	1	13274	4	1 1/4	13284
1	1	13276	5	1 3/4	13286
2	1 1/4	13278	6	1 3/4	13288

GROMMET KITS

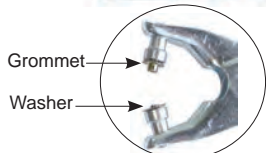

Refills also available
**Osborne No. G1S, N1S,
& B1S**

Osborne No. K257-00

Kit includes Osborne No. 257-00 Grommet Setting Plier, No. 245 Hole Punch and one gross of grommets No. G1-00. This kit sets 3/16" hole diameter grommets. Carded for display purposes.

Overall length (inches)	Card (inches)	Weight (oz.)	UPC No.
8	11 x 4	12	13292

Osborne No. K257N-00

This grommet kit is similar to Osborne No. K257-00 but with **nickel** finish grommets. Also carded for display purposes. UPC No. 13295.



SET-IT-YOURSELF GROMMET KIT



**Osborne No. K234
(With brass plain grommets)**

Hang up display card is packed in an easy to use DISPLAY BOX. Complete instructions on back of card. Kit includes: one wood block, one hole cutter, one setting die and brass grommets and plain washers. Available in 6 sizes listed below. Card measures 6-7/8" x 9-3/4".

**Osborne No. K231
(With nickel plain grommets)**

Similar to our Osborne No.K234 series but with nickel finish grommets and plain washers. Cards measures 6-7/8" x 9-3/4".

**Osborne No. K233
(With dull black plain grommets)**

Similar to our Osborne No.K234 series but with dull black grommets and plain washers. Cards measures 6-7/8" x 9-3/4".

Size No.	Hole size (inches)	Grommets per card	Weight ea. (oz.)	K234 UPC No.	K231 UPC No.	K233 UPC No.
00	3/16	4 dozen	14	13318	13306	13306
0	1/4	4 dozen	14	13320	13308	13308
1	9/32	4 dozen	15	13322	13310	13310
2	3/8	2 dozen	17	13324	13312	13312
3	7/16	2 dozen	18	13326	13314	13314
4	1/2	2 dozen	19	13328	13316	13316

HOME GROMMET KITS



Osborne No. K235

A complete and affordable kit for consumer use. Each kit consists of a No. 235 grommet die, a No. 245 cutting punch, three dozen **brass** plain rim grommets and washers, a small cutting board and complete instructions. Sizes 5 and 6 have 18 grommets.

Osborne No. K232

Same as the K235 series but with **plain rim nickel finish** grommets. Same sizes and packaging.

Size No.	Hole size (inches)	Grommets per card	Weight ea. (oz.)	K235 UPC No.	K232 UPC No.
00	3/16	3 dozen	14	13293	13264
0	1/4	3 dozen	14	13294	13263
1	9/32	3 dozen	15	13296	13265
2	3/8	3 dozen	17	13298	13266
3	7/16	3 dozen	18	13300	13267
4	1/2	3 dozen	19	13302	13268
5	5/8	18 ea.	22	13304	13270
6	13/16	18 ea.	24	13305	13271

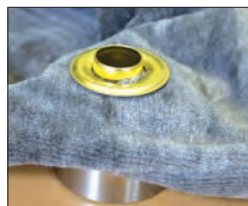



OSBORNE

PRESS MACHINES & DIES

HAND PRESS MACHINE

Osborne No. W-1

Cuts leather and sets SNAPS, GROMMETS, VENTILATORS and RIVETS. Dies are sold separately. It has a reinforced frame and handle. Bolts to a table for added stability. Comes with a nylon block for cutting holes on the leather. 22" height. Weighs 19 lbs. UPC No. 75000. Some replacement parts are also available.

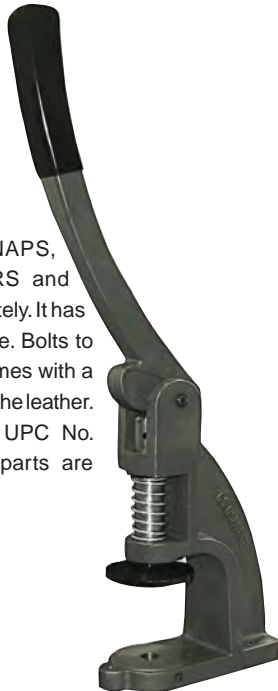

PNEUMATIC MACHINE

Osborne No. W-3

Cuts leather and sets SNAPS, GROMMETS, VENTILATORS and RIVETS. Operates with 60 to 120 lbs. of compressed air. Foot pedal included. Clear plastic safety guard locks the machine. Easy to assemble and mount to bench or work station. Full instructions provided. 23" height. Weighs 47 lbs. UPC No. 75010.

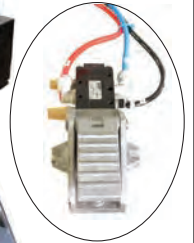

GROMMET DIE & HOLE CUTTER SET

Precision machined dies and hole cutter. Sets plain or spur grommets sizes: 00, 0, 1, 2, 3, 4, 5, 6, 10, 12 & 15.

TO SET PLAIN GROMMETS

Osborne No.	WDIGRC00	WDIGRC0	WDIGRC1	WDIGRC2	WDIGRC3
Grommet size	00 (3/16")	0 (1/4")	1 (9/32")	2 (3/8")	3 (7/16")
UPC No.	75850	75854	75858	75861	75869

Osborne No.	WDIGRC4	WDIGRC5	WDIGRC6	WDIGRC12	WDIGRC15
Grommet size	4 (1/2")	5 (5/8")	6 (13/16")	12 (1-9/16")	15 (2")
UPC No.	75873	75877	75883	75881	75889



TO SET SPUR GROMMETS

Osborne No.	WDISGR0	WDISGR1	WDISGR2	WDISGR3	WDISGR4
Grommet size	0 (1/4")	1 (5/16")	2 (3/8")	3 (7/16")	4 (9/16")
UPC No.	75831	75835	75837	75839	75841

Osborne No.	WDISGR5	WDISGR6	WDISGR7	WDISGR8	WDISGR10
Grommet size	5 (5/8")	6 (3/4")	7 (15/16")	8 (1-1/16")	10 (1-1/2")
UPC No.	75843	75845	75847	75849	75879

VENTILATOR DIE & HOLE CUTTER SET

Used to set ventilators of 1" or 3/4" diameter.



Osborne No.	Ventilator size	UPC No.
WDIVC34	3/4"	76300
WDIVC1	1"	76292

RAPID RIVET DIE SET



Osborne No. WDIRI41

Sets: Double End cap rivets & Rapid Rivets. Small cap 3/8" diameter and large cap 1/4". Set composed of 4 pieces. 2 pcs. are used to set 1/4" size and the other for the 3/8" size. Instructions included.

SNAP DIE SET

Osborne No. WDISN41

4 pcs. set. Used to set 5/8" standard snaps.



SNAP DIE SET

Osborne No. WDISN201

4 pcs. set. Used to set 1/2" baby snaps.



SCRATCH COMPASS



Osborne No. 34

A solid steel multi-purpose, polished scratch compass which includes one point and three scratchers; small, medium and large. For gouging circles or decorative designs or used along the edge for gouging sewing channels, etc.

Extra scratchers	UPC No.	Extra points	UPC No.
34-1 Small	57084	34-P	07090
34-2 Medium	57086		
34-3 Large	57088		

Max. opening (inches)	Weight ea (oz)	UPC No.
8 1/2	4	07082

SCRATCH COMPASS - English Style



Osborne No. 38-C

Polished cutting edge - hardened through to hold sharpness.

Length (inches)	Weight ea (oz)	UPC No.
6 5/8	5	07084

WING DIVIDER - Solid steel - Fully polished



CARDER FOR HANG UP DISPLAY

Osborne No. 106

The nuts on the wings are steel. Washers are of turned steel. The points are carefully hardened and every care is taken with the threads of the screws which hold the legs in position on the wings. The springs are carefully tempered and are made for easy adjustment while holding the legs firmly.

Size (inches)	Max. opening (inches)	Weight ea (oz)	UPC No.
6	6	4	57012
8	8	5	57014
10	10	7	57016
12	12	9	57018

Replacement Parts		
Osborne No.	Description	UPC No.
106-B	6" Bar	07022
106-BL	10" or 12" Bar	07024
106-M	8" Bar	07026
106-KN	Knurled nut	07028
106-S	Wing screw	07030
106-SP	Spring	07032

OUTSIDE CALIPER - Fully polished



Osborne No. 112

Fully polished with durable construction. 3 sizes available.

Size (inches)	Max. opening (inches)	Weight ea. (oz)	UPC No.
6	8	2	57062
8	12	3	57064
10	16	5	57066



BONE FOLDER

Osborne No. 464



Packed in hang up display plastic bag.

Highly polished genuine cattle bone folder for pasting and folding. Also for burnishing Latrone sheets, lettering, gold leaf etc. 6-1/4" long. UPC No. 67478.

Length (inches)	Weight ea (oz)	UPC No.
6 1/4	1	67478

SYNTHETIC BONE FOLDER

Osborne No. 465

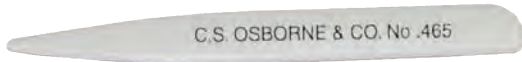

Packed in hang up display plastic bag.

Similar to our Osborne No. 464 but it is made of polished nylon.

Length (inches)	Weight ea (oz)	UPC No.
6 1/4	1	67484

STRAIGHT BONE FOLDER

Osborne No. 727A



Straight real high polished genuine cattle bone folder for pasting and folding. Also used for burnishing Latrone sheets, lettering gold leaf, etc. Small eye in one end to hang up. Available in 3 lengths. Specify your preference when ordering.

Osborne No.	Length (inches)	Weight ea (oz)	UPC No.
727A/15	6	1	14664
727A/18	7 1/8	2	14666
727A/20	8	2	14668

BENT BONE FOLDER

Osborne No. 727

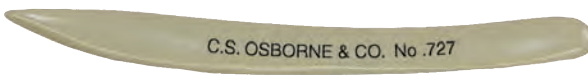

Bent real high polished genuine cattle bone folder for pasting and folding. Also used for burnishing Latrone sheets, lettering gold leaf, etc. Available in 3 lengths. Specify your preference when ordering.

Osborne No.	Length (inches)	Weight ea (oz)	UPC No.
727/15	6	1	14658
727/18	7 1/8	2	14660
727/20	8	2	14662

SADDLERS' SEAT STUFFING STEEL

Osborne No. 117



Hand forged of quality 5/16" stock steel. Finished blade. Hardwood handle with nickel plated ferrule. Width of the point is 1/2". Available in 4 lengths. Specify preference when ordering.

Osborne No.	Overall length (inches)	Weight (oz.)	UPC No.
117	13	1	64186
117-16	16	2	64187
117-20	20	3	64788
117-22	22	3	64789



Made in the traditional manner with the finest grades of steel. Each edge tool is hand edged and tested. Fully polished.

COMMON EDGE TOOL



Osborne No. 125

Easily bevels and rounds off edges of straps and all soft leather. Polished, American hardwood maple handle with brass ferrule.

Size No.	00	0	1	2	3	4	5	6
Width (inches)	3/32	1/8	9/64	5/32	3/16	13/64	7/32	3/8
Weight ea (oz)	1	1	1	1	1	1	1	1
UPC No.	67072	67074	67076	67078	67080	67082	67084	67086

FINEST EDGE TOOL - Drop forged



Osborne No. 126

Drop forged of highest quality steel for long life and effective use. Fully polished, American hardwood maple handle with brass ferrule.

Size No.	0	1	2	3	4	5	6
Width (inches)	1/16	3/32	1/8	5/32	3/16	7/32	1/4
Weight ea (oz)	2	2	2	2	2	2	2
UPC No.	67090	67094	67096	67098	67100	67102	67104

EDGER



Osborne No. 127

Ideal to round the edges of leather, even very fine leather. Use the lower number sizes for lightweight leather and the higher number sizes for heavier leather. Perfect for gouging folds in light leather or trimming excess welts. American hardwood maple handle.



Size No.	1	2	3	4
Width (inches)	1/32	1/16	5/64	3/32
Weight ea (oz)	1	1	2	2
UPC No.	67112	67114	67116	67118

BISSONNETTE EDGE TOOL - Straight shank



Osborne No. 127.5-S

The Bissonnette edge tool can be pushed or pulled to bevel the edges. Works very quickly. Comes with straight shank. Fully polished, American hardwood maple handle with brass ferrule.



Edge back view



Size No.	00	0	1	2	3	4	5	6
Width (inches)	1/16	5/64	3/32	7/64	9/64	11/64	13/64	7/32
Weight ea (oz)	1	1	1	1	1	1	1	1
127.5-S UPC No.	67143	67144	67146	67148	67150	67152	67142	67156
127.5-B UPC No.	67128	67130	67132	67134	67136	67138	67140	67142

Osborne No. 127.5-B

Same as above but with bent shank.

WESTERN STYLE EDGE TOOL - Straight shank



Osborne No. 133-S

With tips bent up. Best suited for saddlery and similar work. Comes with straight shank. Fully polished, American hardwood maple handle with brass ferrule.



Edge back view



Size No.	00	0	1	2	3	4
Width (inches)	1/64	1/32	3/64	1/16	7/64	9/64
Weight ea (oz)	1	1	1	1	1	1
133-S UPC No.	67178	67189	67190	67191	67192	67193
133-B UPC No.	67177	67184	67185	67186	67187	67188

Osborne No. 133-B

Same as above but with bent shank.



ADJUSTABLE GOUGE - Patented

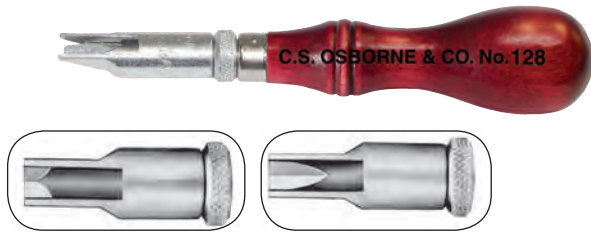

Osborne No. 128

Excellent tool for gouging folds, easy adjustment to any depth. The 90° degree or V-shaped gouge is used on notebooks, cases, handbags, where a sharp right angle fold is desired.

Size No.	Blade width (inches)	Weight ea (oz)	UPC No.	Size No.	Blade width (inches)	Weight ea (oz)	UPC No.
1	3/32	4	67172	3	5/32	4	67174
2	1/8	4	67173	90°	(V-shaped)	4	67176

FRENCH EDGE TOOL - Drop forged

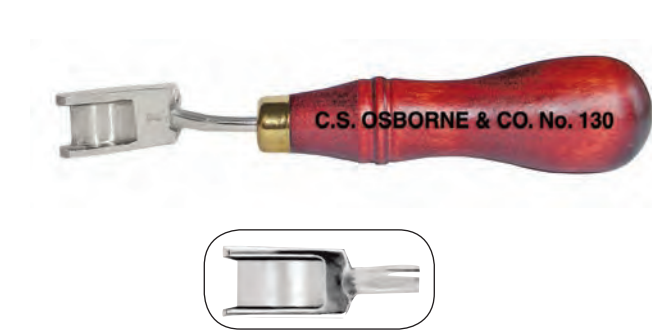

Osborne No. 130

Drop forged of specialty steel made in the traditional Osborne high quality. This precision finished tool is for use by the true professional. It is not used for rounding edges, since the bottom is flat. It lends itself for making beveled edges at any desired angle including miter-joints. It gouges, channels and skives. Fully polished, American hardwood handle with brass ferrule.

Size No.	1	2	3	4	5	6	7	8
Width (inches)	1/16	1/8	3/16	1/4	5/16	3/8	7/16	1/2
Weight ea (oz)	1	1	1	1	1	1	1	1
UPC No.	67170	67180	67171	67181	67175	67182	67177	67183

CREASER



Osborne No. 12

Single ticklers. Hardwood handles. Brass ferrule. 2 sizes available.

Osborne No.	Distance A (inches)	Distance B (inches)	Weight each (oz)	UPC No.
12-1	0.35	0.30	1	67010
12-2	0.45	0.45	1	67012

CREASER



Osborne No. 21

Single edge creasers, hard wood handle, brass ferrule. Will enhance the edges. Place long side of tool against edge of leather as a guide and make impression with short side. Round edges with edge tool before using the creaser. 5 sizes are available.

Size No.	1	2	3	4	5
Width (inches)	1/16	5/64	3/32	7/64	1/8
Weight ea (oz)	1	1	1	1	1
UPC No.	67018	67020	67022	67024	67026

WOOD CREASER



Osborne No. 20-C

Extremely hard maple wood. Makes creases in four sizes, two edges on each end. Use center for edge guide and make impression with outside edge. Weighs 2 oz. UPC No. 67013.

TUCK WAX IRON



Osborne No. 68

Used for spreading wax. Hardwood handle. Blade has slight bend and correct rounded end.

Blade length (inches)	Overall length (inches)	Weight (oz.)	UPC No.
3-3/8	7	1	56128



SHARPENING STONES



Osborne No. 1023

Ultra fine hard Arkansas carving stone used to sharpen Osborne EDGE TOOLS. Measures: 4" x 1" x 1/8" x 3/64".



Osborne No. 1026

India combination coarse/fine bench stone. Should be used with honing or mineral oil for sharpening edge tools and all Osborne KNIVES and PUNCHES. Measures: 6" x 2" x 1".

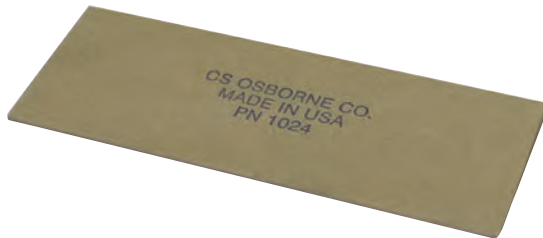

Osborne No. 1024

Ultra fine hard Arkansas round edge slip stone. Also used to sharpen Osborne EDGE TOOLS. Measures: 4-1/2" x 1-3/4" x 3/16" x 1/16"

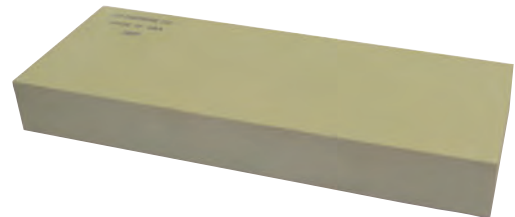

Osborne No. 1028

This 4000 grit waterstone needs to be soaked with water to cut efficiently. Water also flushes away metal particles to keep the surface from becoming clogged. Immerse stone in water for ten minutes prior to use and keep the stone surface wet while sharpening. For all Osborne KNIVES and PUNCHES Measures: 8" x 3" x 1".



Osborne No. 1025

Ultra fine Arkansas carving tool. Used to sharpen Osborne EDGE TOOLS. Measures: 3" x 3/4" x 1/8".



Osborne No. 1021

Specially contoured stone to sharpen the hooks and edges of the Osborne knives. UPC No. 64512.

HOW TO USE SHARPENING STONES

A seven minute long instruction video demonstrating how to use these stones properly on sharpening Osborne tools can be seen online at: <https://www.youtube.com/watch?v=UuSuFZz9b40>

Also you can do a search for leather tools sharpening.



CURVED LIP SHOE KNIFE



Available for right or left hand. Please specify when ordering

Osborne No. 81-R & 81-L

Made from finest quality chromed vanadium steel. Smooth finish. Comfortable hardwood handle. Cuts nearly every material you will run into.

Length of blade (inches)	Width of blade (inches)	Weight ea (oz)	UPC No.
2 3/8	5/8	2	60058

SQUARE POINT KNIFE



Osborne No. 76

The finest quality knife with round plantation tropical hardwood handle, brass ferrule. Widely used in many industries. Steel blade. Made to last.

Length of blade (inches)	Width of blade (inches)	Weight ea (oz)	UPC No.
3 3/4	3/4	2	60042

SQUARE POINT KNIFE



Osborne No. 76 1/2

The white hardwood handle is somewhat shorter and heavier than in the Osborne No. 76. Steel blade.

Length of blade (inches)	Width of blade (inches)	Weight ea (oz)	UPC No.
3 7/8	5/8	2	60046

SQUARE POINT KNIFE - With safety guard



Osborne No. 77

Same as Osborne No. 76 1/2, but furnished with steel safety guard.

Length of blade (inches)	Width of blade (inches)	Weight ea (oz)	UPC No.
3 7/8	5/8	2	60050

BROAD POINT KNIFE



Osborne No. 78

Round polished hardwood handle. Steel blade. Also available with safety guard **Osborne No. 78 1/2** UPC No. 60058.

Length of blade (inches)	Width of blade (inches)	Weight ea (oz)	UPC No.
5	1 1/8	2	60054

BEVEL POINT SKIVING KNIFE



Osborne No. 479

Used for skiving and edge trimming on leather and similar materials. Plated ferrule. Lacquered hardwood handle.

Length of blade (inches)	Weight ea (oz)	UPC No.
3	2	60112

SHARP POINT KNIFE



Osborne No. 79 1/2

White hardwood handle, sharp point knife. A popular knife in the shoe and leather industries. Steel blade.

Length of blade (inches)	Width of blade (inches)	Weight ea (oz)	UPC No.
3 3/4	3/4	2	60060

SEAM RIPPER



Osborne No. 1020

A handy professional tool also used in craft work. Blade is sharpened on three sides.

Length of blade (inches)	Weight ea (oz)	UPC No.
2 7/8	4	60146



ROUND KNIFE



Osborne No. 70

Forged blade edge made with the highest quality steel . Correct oval shaped American hardwood handle with brass ferrule. The world's leading round knife since 1826.

Overall width across blade (inches)	Weight ea (oz)	UPC No.
5	4	60022

HEAD KNIFE



Osborne No. 71

Forged blade edge made with the highest quality steel . Correct oval shaped American hardwood handle with brass ferrule.

Overall width across blade (inches)	Weight ea (oz)	UPC No.
4 1/2	3	60026

LEATHER KNIVES



Osborne No. 67

Made of high quality steel. All purpose leather knives also used as skivers. Round beveled, hand sharpened edges. Nickel plated ferrule with a hardwood handle for long life. Available in 3 sizes. Please specify when ordering.

Osborne No.	Blade dimension	Weight (oz)	UPC No.
67-0	2" x 1 1/8"	2	60028
67-1	4 1/8" x 1 1/2"	3	60030
67-2	4 1/4" x 1 7/8"	4	60031

SHEATH - For Osborne round knives



Osborne No. 75

All leather construction with stitched edges and velcro fasteners. Designed for Osborne knives No. 70 & 71.

Length overall (inches)	Width (inches)	Weight ea (oz)	UPC No.
4 13/16	2	2	60188

SHEATH



Osborne No. 74

All leather construction with stitched edges and velcro fastener. For use with Osborne No. 78 & 78 1/2.

Width overall (inches)	Height (inches)	Weight ea (oz)	UPC No.
6	2 1/8	2	60186

SHEATH - For Osborne knives



Osborne No. 72

A sturdy leather sheath for our industrial knives. Slits fit on belt. Stitched edges reinforced with seven rivets.

Length overall (inches)	Length of pocket (inches)	Width (inches)	Weight ea (oz)	UPC No.
10	5 1/4	2	3	60184



THE SKIFE

NICKEL PLATED

Osborne No. 925



Makes a remarkably easy job of skiving leather and other materials. Increases both speed and accuracy. This essential tool is fitted with a special razor blade. Ideal for restoration work. Extra blades available. Weight each 2 oz. UPC No. 60182.

Osborne No. 925-D 20-blade safety dispenser. UPC No. 04113.

Osborne No. 925-100 Bulk pack of 100 blades. UPC No. 10183.

SKIVING KNIFE

Osborne No. 469-A (right hand) or B (left hand)

Extra quality. Our special design for skiving. Plated ferrule.



Length of blade (inches)	Width of blade (inches)	Weight ea (oz)	UPC No. (rh)	UPC No. (lh)
4 1/2	1 1/4	3	60082	60084

SLOYD KNIVES

Osborne No. 6 and 7

The sloyd knives shown are unequalled in quality by any other sloyd knives on the market. The blades are drop forged from the best quality steel. They are carefully hand ground, tempered and highly polished. The oval handles are made of hardwood.



Osborne No.	Length of blade (inches)	Weight ea (oz)	UPC No.
6	2 3/4	2	60012
7	2 1/2	2	60014

LEAD GLASS KNIFE OR HEAD KNIFE

Osborne No. 73

This knife is widely used by stained glass workers and leather workers. It is furnished with hardwood handle, brass ferrule and hand forged blade.



Length of blade (inches)	Width of blade (inches)	Weight ea (oz)	UPC No.
2	2 1/8	2	60032

HAWKBILL KNIFE

Osborne No. 425

Short blade with sure-grip wood handle. The blade is riveted through the handle.



Length of blade (inches)	Width of blade (inches)	Weight ea (oz)	UPC No.
2 1/2	1	3	60092

HANDLE & EXTENSION BLADES KIT

Osborne No. K-460

An affordable kit composed of one Osborne A & B Handle and one each of Osborne extension blades No. 259-B, 259-C, 259-L & 259-S. Packed in a hang up display card. Individual parts are also sold separately.

Osborne No. 460

A & B Handle with nickel finished head. For use with replaceable extension blades below.

Osborne No. 259

Carefully ground and tempered blades for cutting leather and similar materials. For use with No. 460 handle.

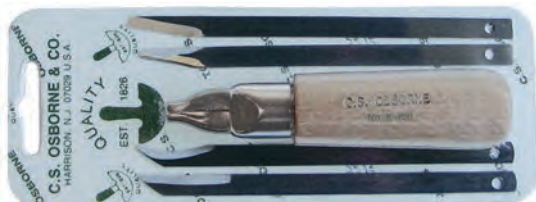

EXTENSION BLADES



Osborne No.	Description	Length (inches)	Steel gauge	Weight ea (oz)	UPC No.
259-B	Bevel	4 3/4	20	1	67302
259-L	Lance				67306
259-S	Sharp				67308
259-C	Curved				67304



THONGING CHISEL



Osborne Nos. 491, 492, 493 & 494

Chisels are made with carefully tempered spring steel blades. Hand ground cutting edges. Nickel plated. Furnished in two sizes, 3/32" and 1/8".

Osborne No.	Description	Weight ea (oz)	UPC No.	Osborne No.	Description	Weight ea (oz)	UPC No.
491 3/32	One prong	2	53272	493 3/32	Three prong	2	53284
491 1/8	One prong	2	53270	493 1/8	Three prong	2	53282
492 3/32	Two prong	2	53278	494 3/32	Four prong	2	53290
492 1/8	Two prong	2	53276	494 1/8	Four prong	2	53288

8 PRONG THONGING CHISEL



Osborne No. 498

Chisels are made with carefully tempered spring steel blades. Hand ground cutting edges. Nickel plated. Furnished in two sizes, 3/32" and 1/8".

Osborne No.	Description	Weight ea (oz)	UPC No.
498 3/32	Eight prong	3	53302
498 1/8	Eight prong	3	53300

DIAGONAL THONGING CHISEL



Osborne No. 494D

Diagonal blade thonging chisel made with tempered spring steel blades. Each blade is on an angle parallel to each other for neater lacing. Nickel plated. Furnished in two sizes, 3/32" and 1/8".

Osborne No.	Description	Weight ea (oz)	UPC No.
494D 3/32	Four prong	1	53296
494D 1/8	Four prong	1	53294

THONGING CHISEL



Osborne Nos. 481, 483 and 484

Thonging chisels made from high grade tempered tool steel **forged in one piece**. Best possible quality for long life. For making slits in leather for lacing, cutting out designs or slits for pronged hardware and many more applications. Furnished in two sizes, 3/32" and 1/8".

Osborne No.	Description	Weight ea (oz)	UPC No.
481 3/32	One prong	1	53254
481 1/8	One prong	1	53252
483 3/32	Three prong	1	53260
483 1/8	Three prong	1	53258
484 3/32	Four prong	2	53266
484 1/8	Four prong	2	53264

STITCHING CHISEL



Osborne No. 700

This punch is designed for saddle stitching. **Forged in one piece**. Prongs 3/32" apart. 1/16" width of the prongs.

Description	Length (inches)	Weight ea. (oz)	UPC No.
Five prong	4 3/4	2	53316

STITCHING CHISEL



Osborne No. 452

Punches the stitching holes in gloves at uniform distances. 1/16" width of prongs. **Forged in one piece**.

Description	Length (inches)	Weight ea. (oz)	UPC No.
Eight prong	4 3/4	2	63312



PRICKING CHISEL



Osborne No. 609

Forged steel.

Size No.	Cuts per inch	Length of cut (inches)	Length overall (inches)	Weight ea (oz)	UPC No.
7	6	1/8	4 9/16	4	56097
8	7	1/8	4 9/16	4	56098
9	8	5/64	4 9/16	4	56099

PLAIN SWIVEL CUTTER



Osborne No. 444

This plain swivel cutter is furnished with medium blade Osborne No. 2 (3/8" only). Chrome plated. Hardened tool steel blade.

Weight ea (oz)	UPC No.
2	67358

Replacement blade	UPC No.
446-B 2 3/8" blade	67366

ADJUSTABLE SWIVEL CUTTER



446-B 1



446-B 2



446-B 3

Osborne No. 446

The adjustable swivel cutter is furnished with 3 hardened tool steel blades. The length of the cutter may be adjusted with a stop nut to suit the hand size of different users. Most important tool for carving leather. Allows precise cuts for quick and intricate design lines.

Weight ea (oz)	UPC No.
5	17362

Replacement blade	UPC No.
446-B 1 1/4" blade	67364
446-B 2 3/8" blade	67366
446-B 3 1/2" blade	67368

INCISING KNIFE



Osborne No. 487

Made specially for incising and carving work. The 3/4" blade is beveled so that it will cut to the exact depth without going too deep. 4-3/4" overall length. Weighs 1 oz. UPC No. 60180.

BRACELET BENDER - Patented



Osborne No. 630

This patented metal tool is designed especially for bending metal bracelets into shape. A bracelet can be bent in a few seconds without the use of a hammer or mallet. Weighs 5 oz. UPC No. 67702.



ZIPPER JIG

Osborne No. 1014

Holds YKK zippers sliders from # 2.5 to # 10. Lower clamp securely holds zipper jig to your counter. Upper clamp is used for locking jig rod in any direction. Also allows you to put zipper on backwards. Fully nickel plated. 5-1/2" x 4-3/4" size is ideal for your work station. Instructions are also provided. Weighs 6 oz. UPC No. 64506.

ZIPPER STOP PLIER

Osborne No. 1012

Manufactured from high quality drop forged steel. Polished head. Colored vinyl handles for easy gripping. Spring loaded allows quick operation. Designed to install any kind of stop on zippers. Light weight to avoid fatigue. Unique jaw design.

Overall length (inches)	Weight each (oz.)	UPC No.
7 1/4	9	64508



ZIPPER STOP TOPS - Stainless Osborne No. 1013

Made of stainless steel. Size number 10. Packed and sold in boxes of 100 pcs. These are the top stops for the zipper chain and can be set using our zipper stop plier Osborne No. 1012. UPC No. 64500.





All modelers have a white rubber gripping area.

MODELER

Osborne No. 454



Diamond point spoon end and fine point tracer end. Special design.



Overall length (inches)	Weight ea (oz)	UPC No.
6 1/2	1	67392

MODELER

Osborne No. 458



One end is equipped with a small "Deer foot" for getting into small places, lettering, etc. The other end can be used as an edge creaser or for double border lines.



Overall length (inches)	Weight ea (oz)	UPC No.
6 1/4	1	67422

MODELER

Osborne No. 467

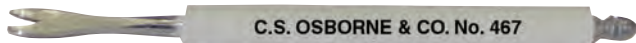

For beveling edges of light leather to prevent fraying.

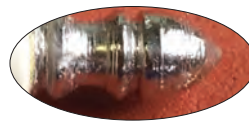

Overall length (inches)	Weight ea (oz)	UPC No.
4 1/4	1	67496

MODELER

Osborne No. 471



The best for all around tooling work. One end is narrow and pointed, suitable for line work or tracing, the other end is flattened, suitable for any type of modeling.

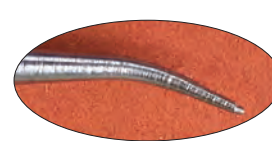

Overall length (inches)	Weight ea (oz)	UPC No.
6 1/2	1	67512

MODELER

Osborne No. 472



This tool is flat at both ends. Excellent for modeling broad surfaces.



Overall length (inches)	Weight ea (oz)	UPC No.
6 1/2	1	67516

MODELER

Osborne No. 473

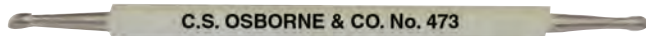

"Deer foot", for beveling and depressing outlines, getting in small places, fine work, lifting petals, etc.



Overall length (inches)	Weight ea (oz)	UPC No.
6 1/2	1	67520



All modelers have a white rubber gripping area.

TRACER

Osborne No. 474

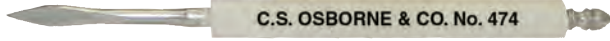

For tracing designs on leather.

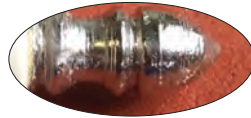

Overall length (inches)	Weight ea (oz)	UPC No.
6 1/2	1	67524

MODELER

Osborne No. 475



A good all around tool. Excellent for straight line work.



Overall length (inches)	Weight ea (oz)	UPC No.
6 1/2	1	67528

MODELER

Osborne No. 476

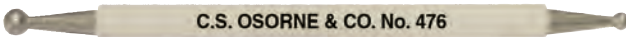

A double ball end modeler for repousse or embossing.



Overall length (inches)	Weight ea (oz)	UPC No.
6 1/2	1	67632

MODELER

Osborne No. 701



A combination bent point and ball end modeler. Useful for stippling.

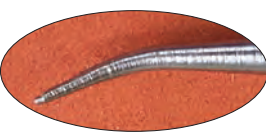

Overall length (inches)	Weight ea (oz)	UPC No.
6 1/2	1	67712

MODELER

Osborne No. 702



"Deer foot" and bent point tracer.



Overall length (inches)	Weight ea (oz)	UPC No.
6 1/2	1	67716

TRACER

Osborne No. 704



All ball point tracing stylus, chrome plated. All metal. No white rubber gripping area.

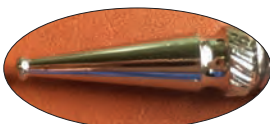

Overall length (inches)	Weight ea (oz)	UPC No.
6 1/2	1	67724

EMBOSSING WHEEL CARRIAGE



Osborne No. 459

Hand embossing wheel carriage (459) with inter-changeable wheels shown here. Excellent for borders, tooling, etc. Can be heated and the design burned into the leather. The carriage is equipped with a thumb screw so that the embossing wheels can be easily changed. Embossing wheels can be ordered as **Osborne No. 459** followed by the pattern style number.

Weight ea (oz)	UPC No.
2	67432

STIPLER



Osborne No. 457

For use in stippling backgrounds.

Length of awls (inches)	Weight ea (oz)	UPC No.
1/2	1	67412

PUSH BEVELER



Osborne No. 447

For tooling leather after carving has been completed.

Length of blade (inches)	Weight ea (oz)	UPC No.
1 7/8	2	67372

DESIGN EDGE LIFTER



Osborne No. 448

Tool used to lift carved areas. Two sizes available.

Osborne No.	Length of blade (inches)	Diameter of stock (inches)	Weight ea (oz)	UPC No.
448-1	2	5/32	1	67382
448-2	2	3/16	1	67384

BLEEDER



Osborne No. 488

For splitting saddle string when braiding. High carbon steel blade stays sharp and is shaped to leave hole open for string. Hardwood handle.

Overall length (in)	Length of blade (in)	Weight ea. (oz.)	UPC No.
5 3/4	2	2	60178

GASKET CUTTER



Replacement blades also available.

Osborne No. 50

Designed for cutting circles, gaskets or washers any size up to and including 24 inches outside diameter. Can be used with bit brace or by hand. Replaceable blades made of the best material and workmanship. Highly polished.



Weight ea (lbs)	UPC No.
1 1/4	18022

Replacement parts		UPC No.
50-B	Extra blade for cutter	18024
50-P	Center pin for cutter	12117
50-R	Gasket cutter rod	18026

SPACE MARKER



Osborne No. 485

Made in 3 different sizes. For marking leather for stitching.

Osborne No.	Cuts per inch	Weight ea (oz)	UPC No.
485-5	5	2	67642
485-6	6	2	67644
485-7	7	2	67646



CLAW TOOL



Osborne No. 200

Narrow at the point to get under heads of decorative nails and tacks without harming leather, wood or fabric. Drop forged.

Blade length (inches)	Overall length (inches)	Weight ea (oz)	UPC No.
3 1/4	7 1/2	3	64220

CLAW TOOL



Osborne No. 202

Sturdy forged steel cobbler's claw tool in a translucent amber handle. Useful also in other professional heavy duty applications.

Blade length (inches)	Overall length (inches)	Weight ea (oz)	UPC No.
3 1/4	7 1/2	3	64220



Osborne No. 201

Same as Osborne No. 202 but with hardwood handle. UPC No. 64224, 3 oz.

CLAW TOOL



Osborne No. 122

This claw tool is especially designed for lifting tacks and small nails. Drop forged steel blade and hardwood handle.

Blade length (inches)	Overall length (inches)	Weight ea (oz)	UPC No.
2 7/8	7 1/4	3	64204

CLAW TOOL



Osborne No. 123 1/2

Boss claw tool. Drop forged sharp blade. Strong plastic handle. Widely used by luggage manufacturers and saddlers.

Blade length (inches)	Overall length (inches)	Weight ea (oz)	UPC No.
2 5/8	7	6	64210

STAPLE REMOVER



Osborne No. 124

Forged from tempered steel. A consistently made Osborne quality product. Carefully hardened for lasting use. Hardwood handle with nickel plated ferrule.

Osborne No. 124-12

Similar to above but with longer blade. Ideal to remove staples in hard to reach places.



Osborne No.	Length of blade (inches)	Overall length (inches)	Weight ea. (oz.)	UPC No.
124	2 1/4	6	4	64014
124-12	8 1/4	12	7	64016



FRENCH CLAW TOOL



Osborne No. 129

Hardwood handle. European style. High quality steel blade.

Overall length (inches)	Blade length (inches)	Weight ea. (oz.)	UPC No.
8 1/2	4	6	64228

STAPLE LIFTER



Osborne No. 120 1/2

The correct angle for removing staples of any size, from the smallest to the longest leg staples. Manufactured from alloy tempered steel. Electronically hardened working ends. Fluted amber cellulose acetate handle to keep from rolling.

Overall length (inches)	Blade length (inches)	Weight ea. (oz.)	UPC No.
6 1/2	4 1/2	4	64006

TACK AND STAPLE REMOVER



Osborne No. 121

Made of forged steel with wooden pinned handle. This tool is manufactured with fine craftsmanship. Carefully milled edges.

Overall length (inches)	Blade length (inches)	Weight ea. (oz.)	UPC No.
6 1/2	2 1/4	2	64010

HEEL REMOVER



Osborne No. 799

Wide blade with curved point. Heavy duty tools of hardened steel. Fluted amber cellulose acetate handle to keep from rolling.

Overall length (inches)	Blade length (inches)	Blade width (inches)	Weight ea. (oz.)	UPC No.
7 1/2	3 3/4	13/16	4	62058

SHOE TACK REMOVER



Osborne No. 791

The perfect shoe tack remover, correct angle with sharp point. Nickel plated ferrule. Hardwood handle.

Overall length (inches)	Blade length (inches)	Weight ea. (oz.)	UPC No.
5 1/2	1 7/8	2	67374

NAIL SET



Osborne No. 797

Manufactured from alloy tempered steel. Heat treated. Fluted amber cellulose acetate handle to keep from rolling. Round concave point design facilitates nail installation. A useful tool in the shoe industry.

Overall length (inches)	Diameter of point (inches)	Diameter of shaft (inches)	Weight ea. (oz.)	UPC No.
6 1/4	1/8	1/4	4	64706



OSBORNE

SPLITTERS

DRAW GAUGE

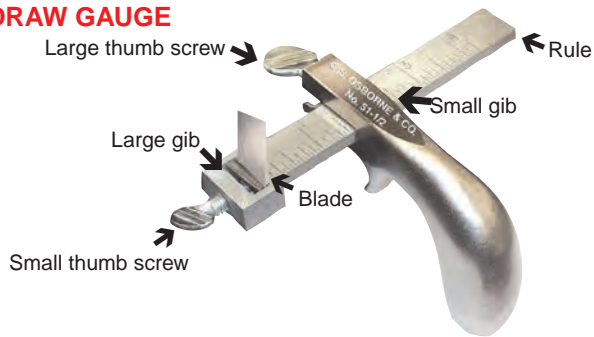

Osborne No. 51 1/2

Aluminum handle draw gauge. Used for cutting leather strips. All metal construction. Manufactured with polished head, slide, and 6" blade. Enameled handle. Cuts straps any width up to 4 inches. Weighs 9 oz. UPC No. 67032.

Replacement parts	51-1/2B	5-1/2GS	51-1/2GL	51-1/2R	51-1/2TSS	51-1/2TS
Description	Extra blade	Small Gib	Large Gib	Rule	Small thumb screw	Large thumb screw
UPC No.	67034	67035	67036	67038	17042	17040

SPLITTING MACHINE

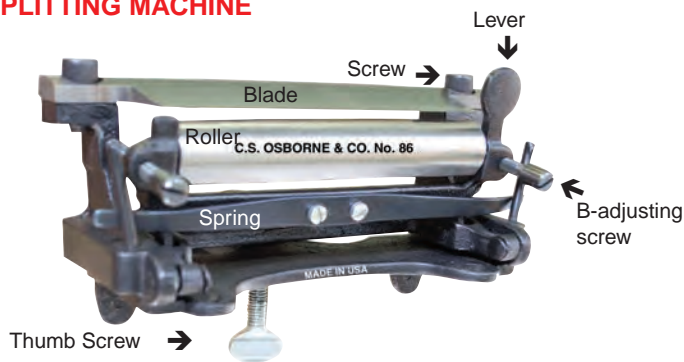

Osborne No. 86

This solid splitting machine is the most professional marketed. It has a sturdy cast iron frame. 6" hollow ground inlaid blade. Easy fine tuning adjustment for even splitting of any thickness of leather. Instruction sheet provided. For the true professional. Weighs 6 lbs. UPC No. 17052.

Replacement parts	86-B	86-BS	86-R	86-SC	86-SP	86-TH
Description	6" Blade	B-adjusting screw	Roler	Screw	Spring	Thumb screw
UPC No.	17054	17055	17056	17058	17060	17062

SPLITTING MACHINE - SKIVER



Osborne No. 86-A

Similar to our C.S. Osborne No. 86 but it has a leverage control roller for easy skiving of leather. Instruction sheet provided. Weighs 7 lbs. UPC No. 17270.

Replacement parts	86-B	86-BS	86-R	86-SC	86-SP
Description	6" Blade	B-adjusting screw	Roler	Screw	Spring
UPC No.	17054	17055	17056	17058	17060

SPLITTING MACHINE

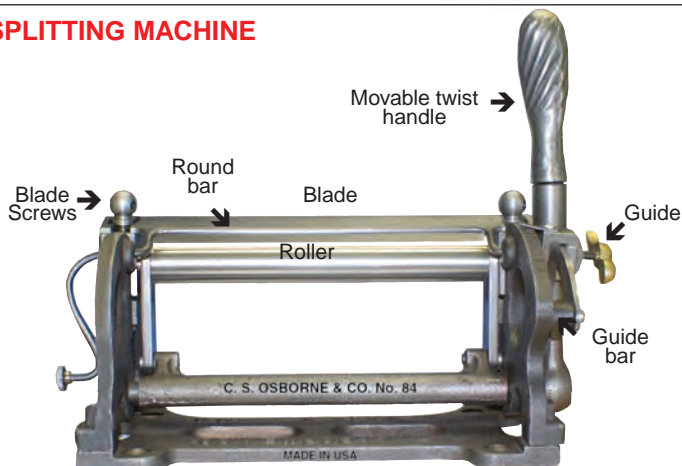

Osborne No. 84

This is the **ORIGINAL OSBORNE 84 Splitting Machine**. Cast iron frame. Made from the original Newark, NJ patterns. Uses a movable twist handle to set blade depth. A locking stop can also be set to return to the same setting. The operator inserts a strap, pushes the handle forward and twists to lock in the position. When pulling leather through, the operator continues to advance the handle forward with the free hand to create a tapered skive. It has a round bar across the blade as a safety feature. 8" hollow ground inlaid blade. Instruction sheet provided. Weighs 12 lbs. UPC No. 17038.

Replacement parts	84-B	84-G	84-R	84-SC	84-GB	84-H
Description	8" Blade	Guide	Rollers	Blade screws	Guide bar	Movable handle
UPC No.	17044	17043	17046	17048	17050	17051



OSBORNE

DECORATIVE NAILS

Osborne quality steel nails with brass finish with 1/2" & 5/8" long nail. Packed 1000 pcs. per box (small sizes) and 250 pcs. per box (larger sizes). Osborne No. 680, 681, 682, 682N, 683, 684 & 6892 are also available in Poly Bags (10 bags of 100 nails each packed into a box). See page 12.

Brass Plated

Actual Sizes	Osborne No.	Finish/Diameter	Length (in)	Nails / box	UPC No.
	6920-BP 1/2	Brass Plated 1/4" diameter	1/2"	1,000	13716
	6925-BP 1/2	Brass Plated 7/16" diameter	1/2"	1,000	13732
	6930-BP 5/8	Brass Plated 3/4" diameter	5/8"	250	13718

Natural

Actual Sizes	Osborne No.	Finish/Diameter	Length (in)	Nails / box	UPC No.
	7250-N 1/2	Natural 7/16" diameter	1/2"	1,000	13802
	7252-N 5/8	Natural 5/8" diameter	5/8"	250	13784
	7254-N 5/8	Natural 3/4" diameter	5/8"	250	13786
	7256-N 5/8	French Natural 1" diameter	5/8"	250	13788

French Natural

Actual Sizes	Osborne No.	Finish/Diameter	Length (in)	Nails / box	UPC No.
	681 1/2	French Natural 3/8" diameter	1/2"	1,000	14452
	682 1/2	French Natural 7/16" diameter	1/2"	1,000	14462
	6936-FN 1/2	French Natural Dark 7/16" diameter	1/2"	1,000	13784
	6938-FN 1/2	French Natural Light 7/16" diameter	1/2"	1,000	13782
	6934-FN 5/8	French Natural Low Dome 5/8" diameter	5/8"	250	13758
	6932-FN 5/8	French Natural High Dome 5/8" diameter	5/8"	250	13738
	6931-FN 5/8	French Natural 11/16" diameter	5/8"	250	13736
	6933-FN 5/8	French Natural 3/4" diameter	5/8"	250	13756
	6935-FN 5/8	French Natural 1" diameter	5/8"	250	13740

Natural Dark

Actual Sizes	Osborne No.	Finish/Diameter	Length (in)	Nails / box	UPC No.
	7260-ND 1/2	Natural Dark 7/16" diameter	1/2"	1,000	13790
	7262-ND 5/8	Natural Dark 5/8" diameter	5/8"	250	13792
	7264-ND 5/8	Natural Dark 3/4" diameter	5/8"	250	13794
	7266-ND 5/8	Natural Dark 1" diameter	5/8"	250	13796

Copper Plated

Actual Size	Osborne No.	Finish/Diameter	Length (in)	Nails / box	UPC No.
	6941-CP 1/2	Copper Plated 7/16" diameter	1/2"	1,000	13734
	6940-CP 1/2	Copper Plated 1/2" diameter Flat Head	1/2"	1,000	13720

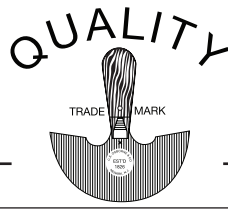

OSBORNE

DECORATIVE NAILS

Antique Oxidized

Actual Sizes	Osborne No.	Finish/Diameter	Length (in)	Nails / box	UPC No.
	6990-AO 1/2	Antique Oxidized 7/16" diameter	1/2"	1,000	13730
	6993-AO 5/8	Antique Oxidized 5/8" diameter	5/8"	250	13744
	6992-AO 5/8	Antique Oxidized 3/4" diameter	5/8"	250	13742
	6995-AO 5/8	Antique Oxidized 1" diameter	5/8"	250	13748

Zinc Plated Matte Pewter

Actual Sizes	Osborne No.	Finish/Diameter	Length (in)	Nails / box	UPC No.
	6980-ZPM 1/2	Zinc Plated Matte Pewter 7/16" diameter	1/2"	1,000	13762
	6986-ZPM 5/8	Zinc Plated Matte Pewter 5/8" diameter	5/8"	250	13806
	6985-ZPM 5/8	Zinc Plated Matte Pewter 11/16" diameter	5/8"	250	13804
	6987-ZPM 5/8	Zinc Plated Matte Pewter 3/4" diameter	5/8"	250	13808
	6988-ZPM 5/8	Zinc Plated Matte Pewter 1" diameter	5/8"	250	13810

Spanish Nail

Actual Sizes	Osborne No.	Finish/Diameter	Length (in)	Nails / box	UPC No.
	6890-SN 1/2	Spanish Nail 3/6" diameter	1/2"	1,000	13710
	6892-SN 1/2	Spanish Nail 7/16" diameter	1/2"	1,000	13700
	685-SN 5/8	Spanish Nail 5/8" diameter	5/8"	250	14497
	6891-SN 5/8	Spanish Nail 3/4" diameter	5/8"	250	13728
	6893-SN 5/8	Spanish Nail 1" diameter	5/8"	250	13818

Nickel Plated

Actual Sizes	Osborne No.	Finish/Diameter	Length (in)	Nails / box	UPC No.
	6948-NP 1/2	Nickel Plated 1/4" diameter	1/2"	1,000	13822
	6950-NP 1/2	Nickel Plated 5/16" diameter	1/2"	1,000	13722
	682N 1/2	Nickel Plated 7/16" diameter	5/8"	1,000	14472
	6960-NP 1/2	Nickel Plated 1/2" diameter	5/8"	1,000	13724
	6965-NP 5/8	Nickel Plated 1" diameter	5/8"	250	13798

Actual Size

Actual Size	Osborne No.	Finish/Diameter	Length (in)	Nails / box	UPC No.
	6901-NP 1/2	Oxford Nickel Plated 7/16" diameter	1/2"	1,000	13726

Old Copper Ground

Actual Size	Osborne No.	Finish/Diameter	Length (in)	Nails / box	UPC No.
	7180-OCG 1/2	Old Copper Ground 7/16" diameter	1/2"	1,000	13800

Super Tack



Actual Size	Osborne No.	Finish/Diameter	Length (in)	Nails / box	UPC No.
	7020-ST 5/8	Super Tack 3/4" diameter	5/8"	250	13820







OSBORNE

DECORATIVE NAILS

Old Gold Speckled

Actual Sizes	Osborne No.	Finish/Diameter	Length (in)	Nails/box	UPC No.
	7110-OGS 1/2	Old Gold Speckled 7/16" diameter	1/2"	1,000	13766
	7111-OGS 1/2	Old Gold Speckled 5/8" diameter	5/8"	250	13768
	7112-OGS 5/8	Old Gold Speckled 3/4" diameter	5/8"	250	13770

Old Copper Lacquer Rolled

Actual Sizes	Osborne No.	Finish/Diameter	Length (in)	Nails/box	UPC No.
	7000-OCLR 1/2	Old Copper Lac. Rolled - Orient 7/16" diameter	1/2"	1,000	13748
	7001-OCLR 1/2	Old Copper Lac. Rolled - Daisy 7/16" diameter	1/2"	1,000	13750
	7002-OCLR 1/2	Old Copper Lac. Rolled - Overlap 7/16" diameter	1/2"	1,000	13780
	7003-OCLR 1/2	Old Copper Lac. Rolled - Oxford 7/16" diameter	1/2"	1,000	13752



Old Gold Speckled Red



Actual Sizes	Osborne No.	Finish/Diameter	Length (in)	Nails/box	UPC No.
	6880-OGSR 1/2	Old Gold Speckled Red 3/8" diameter	1/2"		13708
	6884-OSGR 1/2	Old Gold Speckled Red 7/16" diameter	1/2"	1,000	13790
	6881-OGSR 5/8	Old Gold Speckled Red 5/8" diameter	5/8"	250	13776
	6882-OGSR 5/8	Old Gold Speckled Red 3/4" diameter	5/8"	250	13778

Actual Sizes	Osborne No.	Finish/Diameter	Length (in)	Nails/box	UPC No.
	6970-BRLR 1/2	Bronze Lac. Rolled - Orient 7/16" diameter	1/2"	1,000	13760
	683 1/2	Bronze Lac. Rolled - Daisy 7/16" diameter	1/2"	1,000	14482
	684 1/2	Bronze Lac. Rolled - Overlap 7/16" diameter	1/2"	1,000	14492
	680 1/2	Bronze Lac. Rolled - Oxford 7/16" diameter	1/2"	1,000	14442

Old Gold Dark



Actual Sizes	Osborne No.	Finish/Diameter	Length (in)	Nails/box	UPC No.
	6870-OGSD 1/2	Old Gold Speckled Dark 7/16" diameter	1/2"	1,000	13706
	6871-OGSD 5/8	Old Gold Speckled Dark 5/8" diameter	5/8"	250	13772
	6872-OGSD 5/8	Old Gold Speckled Dark 3/4" diameter	5/8"	250	13774

Actual Sizes	Osborne No.	Finish/Diameter	Length (in)	Nails/box	UPC No.
	6910-BL 1/2	Honey Comb Lac. Rolled Bronze 7/16"	1/2"	1,000	13714
	7210-OSLR 1/2	Honey Comb Lac. Rolled Old Silver 7/16"	1/2"	1,000	13792
	7004-OCLR 1/2	Honey Comb Lac. Rolled Old Copper 1/2"	1/2"	1,000	13754

Actual Sizes	Osborne No.	Finish/Diameter	Length (in)	Nails/box	UPC No.
	7140-BN 1/2	Black Nickel 7/16" diameter	1/2"	1,000	13796
	7100-BLM 1/2	Black Lacquered Matte 7/16" diameter	1/2"	1,000	13764
	7160-BL 1/2	Black Lacquered Glossy 7/16" diameter	1/2"	1,000	13798

Old Brass Speckled

Actual Size	Osborne No.	Finish/Diameter	Length (in)	Nails/box	UPC No.
	6860-OBS 1/2	Old Brass Speckled 7/16" diameter	1/2"	1,000	13704

	6998-AO 1/2	Antique Oxidized Light 7/16"	1/2"	1,000	13751
	6996-AO 1/2	Antique Oxidized Dark 7/16"	1/2"	1,000	13749



OSBORNE

NAILS & TACKS

DECORATIVE NAIL PLASTIC BAGS



Decorative Nails Osborne No. 680, 681, 682, 682N, 683, 684 & 6892 are also available in plastic bags (10 bags with 100 nails packed into a box).

Sold by boxes only, not individually bags.

Please designated by using style number + ("S")

Example: Osborne No. 680S 1/2

QUICK NAILER (DECORATIVE NAIL SETTER)



Osborne No. 777

Patent No. 4079764

FANCY NAIL SPACER FOR SPACING ANTIQUE NAILS.

Set up to 5 nails head to head at one time without damaging the furniture, or your fingers. Exact spacing at the same time! Load large end of tool making sure nails are perpendicular to and shanks are flush with base of tool. Position tunneled section of tool over last nail driven and begin setting nails. Removal of tool may require twisting motion and/or pressure against nail heads with free hand. Use Osborne No. 36 Nylon tip hammer for best results. 6" long. 3 oz. UPC No. 64502.

NYLON TIP MAGNETIC HAMMER



Osborne No. 36

The large face is fitted with a nylon tip to avoid damage to the decorative nails. The other end has an inserted magnet. Used where a soft strike is needed. Lacquered hickory handle. Replacement handles are also available **Osborne No. 33-H** UPC No. 56046. Nylon tips also available separately. **Part No. 36-T** UPC No. 56076

Length of head (inches)	Weight of head (oz)	Magnetic face (inches)	Large face (inches)	Weight ea (oz)	UPC No.
5 1/2	6	1/4	7/16	11	56072

PLASTIC NAIL STRIP



Osborne No. 4802

Used to align the decorative nails, giving the same space between. Works only with the 3/8" diameter decorative nails. Packed and sold 100 strips to a bag.

Amount of nails per strip	Amount of strips per bag	Weight / bag (oz)	UPC No.
100	100	4	78330

BLUED STERILIZED TACKS



Corrugated tacks also available.

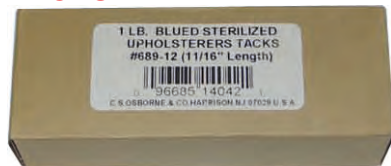

Osborne No. 689C-12

Osborne No. 689

Sharp points and strong, thin oval heads are ideal for attaching all types of webbing, fabric and leather. Sturdy construction and blued finish to protect against rusting. Sterilized by radiation. Sold in 1 lb. boxes. Available in 4 sizes.

Osborne No.	Description	Weight/box	UPC No.
689-3	3/8" Length - Blued sterilized tacks	1 lb.	14038
689-6	1/2" Length - Blued sterilized tacks	1 lb.	14040
689-12	11/16" Length - Blued sterilized tacks	1 lb.	14042
689-12C	11/16" Length - Same but corrugated	1 lb.	14044



DECORATIVE NAIL PLIERS



Osborne No. 601

Hardened steel, top quality. Very convenient size for removing antique nails.

Overall length (inches)	Width (inches)	Weight ea (oz)	UPC No.
7	1 3/4	6	54212

DECORATIVE NAILS & STAPLE PULLER

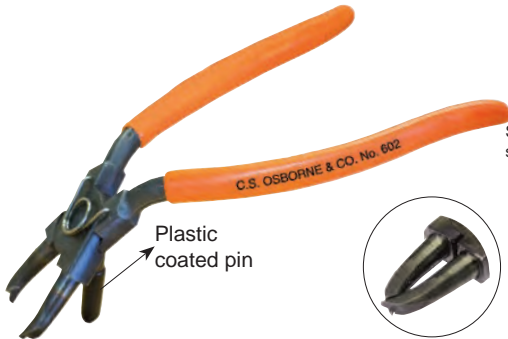

Sharp points with hook design overlap when closed.



Plastic coated pin



Osborne No. 602

Forged steel. Blued finished. Vinyl handles to add comfort and prevent from slipping. Opening spring. The uniquely design welded pin gives leverage when pulling out the staples and is plastic coated to prevent any damage to furniture. Sharp points with a hook design overlap when closed to pull staples out with ease.

Overall length (inches)	Maximum head opening (inches)	Weight ea. (oz)	UPC No.
8	3/4	9	54214

SHOEMAKER'S PINCER



FLUSH CUT



Osborne No. 93

Shoemaker's heel pincers or carpenter's pincers. Forged steel and polished jaws. Cutting edge outside **flush cut**, inside bevel cut.

Overall length (inches)	Width of the jaw (inches)	Weight ea. (oz.)	UPC No.
8	1	13	54112

LASTING PINCER



Osborne No. 233

Drop forged. With box joint and carefully milled teeth. Polished head. Vinyl handles to add comfort.

Overall length (inches)	Width of the jaw (inches)	Weight ea. (oz.)	UPC No.
8-1/2	5/16	13	54032

LASTING PINCER



Osborne No. 322

Drop forged tool steel with serrated jaws curved downward to grip the edge of the uppers to keep them in line with the direction in which the leather is pulled. Used for straining the leather uppers over the last. Small jaw. Polished steel head. Vinyl handles to add comfort.

Overall length (inches)	Width of the jaw (inches)	Weight ea. (oz.)	UPC No.
10	1/2	14	54030

CANTLE PLIER



Osborne No. 10

The forged nickel plated Cantle Plier is used to tightly form the leathers around the perimeter of the cantle of a saddle. The jaws are smooth so they don't mar the leather. They also can be useful for shaping leather handles.

Overall length (inches)	Width of the jaw (inches)	Jaw depth (inches)	Weight ea. (oz.)	UPC No.
9	3/4	1-3/4	15	52024



SADDLERS' DUCKBILL PLIER



**Osborne No. 98 (Serrated jaw)
Osborne No. 98-S (Smooth jaw)**

Drop forged from quality tool steel. Polished completely. Jaws are neatly scored inside on the No. 98. Carefully designed to fit the hand. Vinyl handles to add comfort.

Overall length (inches)	Width of the jaw (inches)	Weight ea. (oz.)	UPC No. (serrated jaw)	UPC No. (smooth jaw)
6 1/2	3/4	5	54016	54018

DUCKBILL PLIER



**Osborne No. DB1 (Serrated jaw)
Osborne No. DB1-S (Smooth jaw)**

Made of cast malleable iron. Extra wide jaws. Special small finger crook. Nickel plated, popular style.

Length (inches)	Width of jaw (inches)	Weight ea (oz)	UPC No.	UPC No. (smooth jaw)
7	1	6	54012	54014

ARTIST CANVAS STRETCHING PLIER



Osborne No. 249

This plier designed for today's trend to the clean line (or "hard edge") look of canvas made taut over three sides of its wooden stretcher frame. Parallel extensions permit pressure to be applied to the inner side of the wooden stretcher. Works also on heavy and primed canvas.

Length (inches)	Width of jaw (inches)	Weight ea (oz)	UPC No.
9	3 3/8	18	54046

CANVAS OR LEATHER PLIER



Osborne No. 250

Perfectly mating rounded teeth secure no-slip on leather or canvas. Plier is made with hammer jaw, the hammer acts as a lever if a strong pull is required or can be used as a hammer.

Length (inches)	Width of jaw (inches)	Weight ea (oz)	UPC No.
8 1/2	3 3/8	18	54042

CANVAS OR LEATHER PLIER



Osborne No. 251

Same as Osborne No. 250 but with shorter jaw.

Length (inches)	Width of jaw (inches)	Weight ea. (oz.)	UPC No.
8 1/2	1-1/2	16	54044



DIAGONAL CUTTING NIPPER



Osborne No. 91

This rugged drop forged nipper is ideal for cutting wire, nails, etc. Polished head, vinyl grips.

Length (inches)	Weight ea (oz)	UPC No.
7 3/8	9	54082

DIAGONAL CUTTING NIPPER



Osborne No. 3377

Solid tough nipper for cutting wire, nails, etc. Vinyl grips. The toughest.

Length (inches)	Weight ea (oz)	UPC No.
6 7/8	7	54072

DIAGONAL CUTTING NIPPERS



Osborne No. 299N

Osborne No. 299PG

Osborne No. 299

Compound leverage construction makes for easy operation and cutting hardened wire. The tolerance of the blades are firm enough for cutting soft wire. Return spring is fitted and positive stop provided to facilitate handling. Also available with vinyl grips and carded for display purposes.

Osborne No.	Handle type	Length (inches)	Weight ea. (oz)	UPC No.
299N 5-1/2	Nickel finish	5-1/2	5	54052
299PG 5-1/2	Vinyl	5-1/2	6	54055

CUTTING NIPPER



Osborne No. 80

Combination cutting nipper for tacks and nails. This nipper cuts tacks and nails in hard to reach places. The extra length and curved front are useful in cutting tack points protruding through an insole when shoemaking and repairing. Made of high quality tool steel. Cuts flush and will leave no upstanding burrs. 8-3/4" red vinyl grips. 12-3/4" overall. UPC No. 54084.

Overall (inches)	Handle type	Length of jaw (inches)	Weight ea. (lbs) (oz)	UPC No.
12-3/4	Vinyl	1-1/4	1 4	54084

END CUTTING NIPPER



BEVEL CUT

Osborne No. 94

An excellent small nipper. Made of drop forged steel, solid jaws. Black finished handle, polished jaws. Flush cut.

Length (inches)	Weight ea (oz)	UPC No.
6 3/8	7	54122

CUTTING NIPPER



Osborne No. 301

End cutting nipper, compound leverage with spring return.

Length (inches)	Weight ea (oz)	UPC No.
6 1/2	10	54102



CANING CHISEL



Osborne No. 405

Hardened and tempered steel. Available in two sizes to fit groove size. Has a translucent cellulose acetate handle. Carded for display.

Osborne No.	Blade length (inches)	Blade width (inches)	Overall Length (inches)	Weight ea (oz)	UPC No.
405 1/8	4	1/8	8	3	53222
405 3/16	4	3/16	8	3	53224

CANING TOOL



Osborne No. 406

This caning tool can be used to move individual or multiple canes during any stage of the caning process by hooking one or both pins behind the cane and pulling it into position. This tool makes caning easier with less repetitive motion and lighter finger load.



Length (inches)	Weight ea (oz)	UPC No.
5 1/4	1	64336

PATENT PENDING

CANING NEEDLE

Weaving strands with Osborne No. 407 needle.

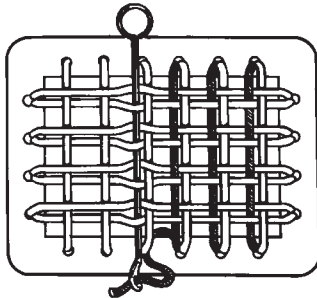

Osborne No. 407

NICKEL PLATED. Makes weaving in the strands faster and easier. Snake the needle through the strands, thread the eye and pull needle across the frame.

Overall length (inches)	Size of eye (inches)	Weight ea (oz)	UPC No.
21	1/8 x 3/32	1	64338



BASKET WEAVING TOOL



Osborne No. 423 & 423-L

Hardwood handle. Ideal for work in the more confining space of basket weaving. Also available with bigger eye **Osborne No. 423-L**.

Osborne No.	Overall length (inches)	Size of the eye (inches)	Weight ea. (oz)	UPC No.
423	5-1/4	1/8 x 3/32	1	64339
423-L	5-1/4	3/8 x 5/16	1	64346

BASKET WEAVING TOOL



Osborne No. 424-S

Stainless steel with straight blade. Round polished hardwood handle. Ideal for working in water.

Blade length (inches)	Overall length (inches)	Weight ea (oz)	UPC No.
3 3/8	7	1	64337



Osborne No. 424-B

Stainless steel with bent blade. Round polished hardwood handle. Ideal for working in water.

Blade length (inches)	Overall length (inches)	Weight ea (oz)	UPC No.
3 1/8	7	1	64335



OSBORNE

SHEARS & RULERS

E-Z CUT LEATHER SHEAR



Osborne No. 708

This shear cuts up to 8 oz. leather with ease. No other like it. Knife edge, shiny nickel finish. Blunt points. Each blade forged of one piece.

Length (inches)	Length of cut (inches)	Weight ea (oz)	UPC No.
8 1/4	3	7	60692

LEATHER OR BELT SHEAR



Osborne No. W8BLTN

Designed for cutting leather, belting, webbing and similar material. Serrated blade prevents leather from slipping.

Length (inches)	Length of cut (inches)	Weight ea (oz)	UPC No.
8 5/8	3 1/8	12	60708

BENT TRIMMER'S SHEARS



Osborne No. 164

Forged steel, enameled handles, polished blades. An inexpensive shear. Ideal for use in class instruction.

Length (inches)	Length of cut (inches)	Weight ea (oz)	UPC No.
8	3 1/2	5	60570

ALUMINUM RULE (inches and metric)



Osborne No. 161

Made of anodized aluminum. One side shows graduation in inches along both edges with measurements also from center of rule. When turned over, the opposite side of the rule has graduations in metric along one side. Hole on one end for hanging display.

Length (inches)	Width (inches)	Thickness (inches)	Weight ea (oz)	UPC No.
60	1 1/4	1/8	8	64092

ALUMINUM STRAIGHT EDGE RULE

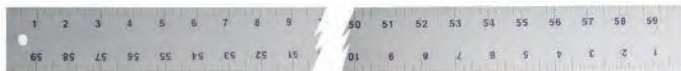

Osborne No. 60SE

This is one of the finest measuring rules on the market. Markings on one side only. Heavy wide aluminum. Hole punched on one end for hanging display.

Length (inches)	Width (inches)	Thickness (inches)	Weight ea (oz)	UPC No.
60	2	1/8	26	64082

WOOD RULE



Osborne No. 160

Made from finest dried northern hard maple with solid brass ends to meet all state measuring standard codes. Smooth finish with clear lacquer to bring out natural beauty of the wood. 1/8" calibrations engraved on both sides (not printed). Hole punched on one end for hanging display. Available in 3 different lengths.

Osborne No.	Length (inches)	Width (inches)	Thickness (inches)	Weight ea. (oz.)	UPC No.
160-3C	36	1 1/2	1/4	8	64084
160-5C	60	1 1/2	1/4	12	64086
160-6C	72	1 1/2	1/4	18	64088

ALUMINUM STRAIGHT EDGE RULER



Osborne No. 802

One edge for standard measurements, one edge for metric. Sturdy and wide - just right for marking selvage edge of cloth. Scales etched in black on silver background, one side only. Finish anodized for permanence. Hole punched on one end for hanging display. Available in 3 different lengths.

Osborne No.	Length (inches)	Width (inches)	Thickness (inches)	Weight ea. (oz.)	UPC No.
802-36	36	1 1/2	1/8	9	64094
802-54	54	1 1/2	1/8	13	64096
802-60	60	1 1/2	1/8	15	64098



SEWING PALM



Osborne No. 266

A strong palm with an iron thimble encased in vinyl. Riveted joints. Furnished either in right or left hand. Right hand will be furnished unless otherwise specified.

Osborne No.	Description	Weight ea (oz)	UPC No.
266-RH	Sewing palm - right hand	3	67332
266-LH	Sewing palm - left hand	3	67334

OPEN END THIMBLE



Osborne No. 510

Nickel plated brass thimbles. Coarse grate. 7 sizes are available.

Osborne No.	Inside diameter of base (mm)	Weight ea. (oz)	UPC No.	Osborne No.	Inside diameter of base (mm)	Weight ea. (oz)	UPC No.
510-5	13.2	1	67650	510-11	16	1	67656
510-7	14	1	67662	510-12	17	1	67654
510-9	14.5	1	67660	510-13	18	1	67652
510-10	15.4	1	67658				

CLOSED END THIMBLE



Osborne No. 511

Nickel plated brass thimbles. Coarse grate. 7 sizes are available.

Osborne No.	Inside diameter of base (mm)	Weight ea. (oz)	UPC No.	Osborne No.	Inside diameter of base (mm)	Weight ea. (oz)	UPC No.
511-5	13.2	1	67684	511-11	16	1	67676
511-7	14	1	67680	511-12	17	1	67674
511-9	14.5	1	67682	511-13	18	1	67672
511-10	15.4	1	67678				

AUTOMATIC AWL



Osborne No. 413

An excellent tool for sewing leather, canvas and similar materials. The awl carries a spool of waxed polyester black thread on the handle. Hollow handle holds extra curved needle and wrench. Directions furnished with each awl explaining how automatic awl lock stitch can be effected in repair work. Furnished with one straight (Osborne No. 413N 8) and one curved diamond point (Osborne No. 413N 6) needle.

Straight Needle



Curved Needle



Osborne No.	Description	Weight ea (oz)	UPC No.
413	Automatic awl	3	62142



Osborne No. 413ST
1/4 lb. tube of thread
85 yards



Osborne No. 413R reel of thread
12½ yards. Waxed polyester strand
(0.27mm diameter).

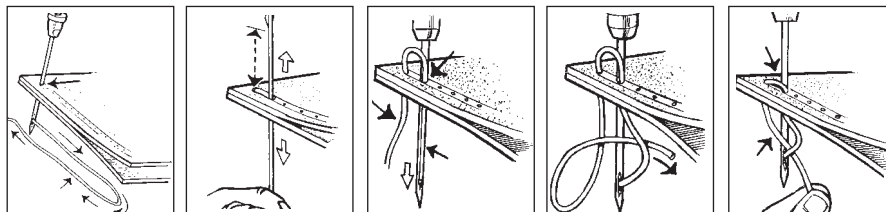

Replacement parts		
Osborne No.	Description	UPC No.
413N 5	Short straight needle	62192
413N 6	Curved needle	62194
413N 8	Coarse straight needle	62196
413R B	Reels of black thread	62182
413R BR	Reels of brown thread	62184
413R W	Reels of white thread	62186
413ST B	Black thread 1/4 lb. tube	12162
413ST BR	Brown thread 1/4 lb. tube	12164
413ST W	White thread 1/4 lb. tube	12166



OSBORNE

LACING TOOLS & GLUE

LACE CUTTER

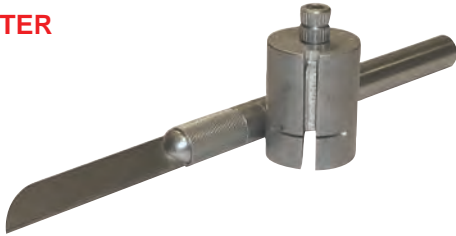

Osborne No. 1000 & 1003

Looks simple and is simple, cuts uniform strips (1/8" to 3/8" wide) of the suede or grain leather of your own choosing. Calibrated fulcrum and knife come with easily followed instruction sheet. Extra blades available separately, **Osborne No. 1003**. Weight each 3/16 oz. UPC No. 67742.

LACING PLIER

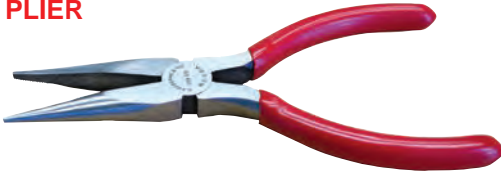

Osborne No. 103¹/₂

Lacing plier, forged steel. Single joint, polished jaws. Slightly serrated jaw. Vinyl handles. Great for stretching material where space is too limited.

Overall (inches)	Handle type	Weight ea. (oz)	UPC No.
5-1/2	Vinyl	3	54022

LACING NEEDLE



Osborne No. 411¹/₂

Split lacing needle with 2 prongs. Tempered spring steel. Lacing may be inserted inside the clip. 2-1/2" long. UPC No. 17342.

FID



Osborne No. 477

Fid or belt awl. Blunt awl for stretching and enlarging holes in leather for easy lacing. Also used for stippling, tightening or loosening knots, etc. Hardwood handle. 2-1/4" long. 5" overall. UPC No. 67336.

LACING AWLS



Osborne No. 421 & 421-L

Ideal for lacing small objects. Hardwood handle. Available in 2 lengths:

Osborne No.	Overall length (inches)	Blade length (inches)	Weight ea. (oz)	UPC No.
421	6-3/4	2-1/2	1	62072
421-L	9-1/4	5	2	62074

COLLAR AWLS



Osborne No. 8

Forged collar awl with hardwood handle. Riveted tang goes completely through the handle for added strength. Sharp cutting edges to punch its own slit. For heavy laces.

Blade length (inches)	Overall length (inches)	Weight ea (oz)	UPC No.
6-1/4	10-1/4	2	62062



Osborne No. 8-B

Forged collar awl with blunted and polished edges to be used on pre-punched leather. Hardwood handle. UPC No. 62064.

Blade length (inches)	Overall length (inches)	Weight ea (oz)	UPC No.
6	10	2	62064

GLUE STICKS



Osborne No. 2000

Hot melt adhesive . Size 7/16" diameter by 10" long. Packed 12 sticks per bag. UPC No. 14636.



Osborne No. 2003 Glue sticks-BULK

Same as Osborne No. 2000 but bulk packed 22 lbs. per box. Each box contains approximately 375 glue sticks. UPC No. 64638.



WAXED TAPERED HANDSEWING THREADS

Our waxed, tapered handsewing threads are made from the highest quality yarns using 100% filament polyester (much stronger than cotton or linen). All threads are fiber dyed for deep coloration throughout, not just dye coated. These threads work exceptionally well with our extensive line of premium HAND SEWING NEEDLES.

Sold per hank (24 individual threads). Available in 4 different colors, 2 different lengths and 3 different gauges. Please see details below.



White

Osborne No.	Description	Color	Length	Gauge	Diameter of thread	Number of strands	UPC No.
433-60 L	60" White tapered thread	White	60"	Light	0.040"	4	12168
433-60 M	60" White tapered thread	White	60"	Medium	0.045"	5	12170
433-60 H	60" White tapered thread	White	60"	Heavy	0.055"	7	12172
433-72 L	72" White tapered thread	White	72"	Light	0.035"	4	12174
433-72 M	72" White tapered thread	White	72"	Medium	0.045"	5	12176
433-72 H	72" White tapered thread	White	72"	Heavy	0.055"	7	12178



Black

Osborne No.	Description	Color	Length	Gauge	Diameter of thread	Number of strands	UPC No.
434-60 L	60" Black tapered thread	Black	60"	Light	0.040"	4	12180
434-60 M	60" Black tapered thread	Black	60"	Medium	0.045"	5	12182
434-60 H	60" Black tapered thread	Black	60"	Heavy	0.055"	7	12184
434-72 L	72" Black tapered thread	Black	72"	Light	0.040"	4	12186
434-72 M	72" Black tapered thread	Black	72"	Medium	0.045"	5	12188
434-72 H	72" Black tapered thread	Black	72"	Heavy	0.055"	7	12190



Brown

Osborne No.	Description	Color	Length	Gauge	Diameter of thread	Number of strands	UPC No.
435-60 L	60" Brown tapered thread	Brown	60"	Light	0.040"	4	12192
435-60 M	60" Brown tapered thread	Brown	60"	Medium	0.045"	5	12194
435-60 H	60" Brown tapered thread	Brown	60"	Heavy	0.055"	7	12196
435-72 L	72" Brown tapered thread	Brown	72"	Light	0.040"	4	12198
435-72 M	72" Brown tapered thread	Brown	72"	Medium	0.045"	5	12200
435-72 H	72" Brown tapered thread	Brown	72"	Heavy	0.055"	7	12202



Natural

Osborne No.	Description	Color	Length	Gauge	Diameter of thread	Number of strands	UPC No.
436-60 L	60" Natural tapered thread	Natural	60"	Light	0.040"	4	12204
436-60 M	60" Natural tapered thread	Natural	60"	Medium	0.045"	5	12206
436-60 H	60" Natural tapered thread	Natural	60"	Heavy	0.055"	7	12208
436-72 L	72" Natural tapered thread	Natural	72"	Light	0.040"	4	12210
436-72 M	72" Natural tapered thread	Natural	72"	Medium	0.045"	5	12212
436-72 H	72" Natural tapered thread	Natural	72"	Heavy	0.055"	7	12214



AWL



Osborne No. 478

Sharp pointed. Tempered blade for piercing leather, sewing and a variety of uses. Hardwood handle.

Blade length (inches)	Overall length (inches)	Weight ea (oz)	UPC No.
2	3 7/8	1	62022

HEAVY DUTY SCRATCH AWL



Osborne No. 4

Made in four sizes for your convenience. Best quality steel blades with rugged amber translucent plastic handles.

Osborne No.	Blade length (inches)	Overall length (inches)	Weight (oz.)	UPC No.
4-1	2 1/2	4 1/2	1	62012
4-2	3 1/2	5 1/2	2	62014
4-3	4 1/2	6 3/4	3	62016
4-4	5 1/2	7 3/4	4	62018

BADMINTON AWL



Osborne No. T-10

Sharp point. Hardwood handle.

Blade length (inches)	Overall length (inches)	Weight ea (oz)	UPC No.
1 1/4	5	1	62032

TENNIS AWL



Osborne No. T-11

Blunt point prevents scratching the leather when aligning, etc. Hardwood handle.

Blade length (inches)	Overall length (inches)	Weight ea (oz)	UPC No.
2 1/2	6 1/4	1	62042

ALL PURPOSE BENT AWL



Osborne No. 18

A varied-purpose tool. Great for hard to reach places in leatherwork. Can be used to remove small staples in grooves. Tempered end.

Blade length (inches)	Overall length (inches)	Weight ea (oz)	UPC No.
5 1/2	9 1/2	4 1/2	62052

HAFT WITH AWL INSERTED



Osborne No. 140

Finest quality. Spring steel awl. Sharp end curved end point.

○Round point

Blade length (inches)	Overall length (inches)	Weight ea (oz)	UPC No.
1 1/4	4 3/4	1	62228



AWL HAFT



Osborne No. 140-H

Made of hardwood. Designed to fit the palm of your hand. Light weight with ring for easy use of thumb for precise stitching. UPC No. 62232.

AWL HAFT



Osborne No. 141

Lacquer finish, brass chuck designed to hold thick awls or wider needles. Knurling on chuck makes it easy to tighten manually. Narrow neck is correct size for one or two turns of thread. Weighs 2 oz. UPC No. 62208

PALM AWL HAFT



Osborne No. 142

Made of lacquered hardwood. Comes with steel chuck and wrench. Shaped to fit in hand. Weighs 2 oz. UPC No. 62210.

PEG AWL HAFT



Osborne No. 143

Made with chuck and wrench to permit easy changing of blades. Leather tipped to prevent splitting when hammered. Lacquered hardwood handle. Weighs 2 oz. UPC No. 62212.

SHOE AWL HAFT



Osborne No. 144

Clear lacquer finish, brass ferrule. Holds awls No. 32, 43, 44 and also needle No. 504-4. Also available with awl No. 32 **Osborne No. 144-32** already inserted & with awl No. 43 **Osborne No. 144-43**.

SEWING AWL HAFT



Osborne No. 145

Knobbed end permits easy grasp and prevents slipping. Also made for wrapping thread. Made of hard maple. Varnished. Comes with chuck and wrench. Weighs 2 ounces. Holds all Osborne awls shown below. UPC No. 62224.

SEWING AWL HAFT



Osborne No. 928

A popular sewing awl haft in Europe. Knurled chuck makes it easy to tighten manually. Weighs 2 oz. UPC No. 65150.



OSBORNE

AWLS

Osborne Awl Blades are the finest in the world. Made from the best special steels and each awl is hand worked.

CURVED DIAMOND POINT AWL



Diamond point

Osborne No. 63

High quality steel. Blued finish. Sharp diamond point. Fits all Osborne awl hafts. Packed and sold by the dozen. 3 sizes are available. Specify when ordering.

Osborne No.	Overall (inches)	Gauge	UPC No.
63-0	2-1/2	13	62130
63-1	2-3/4	12	62132
63-2	3	11	62134

STABBING AWL WITH EYE



Flattened point

○ Round shank

Osborne No. 64

High quality steel. Sharp flattened point with eye. Fits all Osborne awl hafts. Packed and sold by the dozen. 3 sizes are available. Specify when ordering.

Osborne No.	Overall (inches)	Gauge	Eye Dimension (inches)	UPC No.
64-0	3-3/4	15	1/8 x 1/16	62130
64-1	4	13	1/8 x 1/16	62132
64-2	4-1/4	12	1/8 x 1/16	62140
64-3	4-1/2	12	1/8 x 1/16	62134

CURVED DOUBLE POINT AWL



Diamond point

Osborne No. 40

Finest quality. 3-1/2" long. UPC No. 62098. Packed and sold by dozen.

CURVED SEWING AWLS



Flat point

Finest quality.

Osborne No. 31

Size (inches)	2 1/2	3	3 1/2
UPC No.	62082	62084	62086

STABBING AWLS, ROUND POINT



○ Round point

Osborne No. 32

Finest and toughest steel. Available in 2 sizes: 2-1/2" UPC No. 62092 and 3" UPC No. 62094. Packed and sold by dozen.

SADDLERS' HARNESS AWL



Diamond point

Finest quality. Special thin sizes.

Osborne No.	41	42	43	44	45	46	47	48	49	50	52
Size (inches)	1 1/4	1 1/2	1 3/4	2	2 1/4	2 1/2	2 5/8	2 3/4	2 7/8	3	3 1/4
UPC No.	62096	62100	62102	62104	62106	62108	62110	62112	62114	62116	62118

SADDLERS' STITCHING AWL



Diamond point

Finest quality.

Osborne No.	54	56	57	58	59
Size (inches)	2	2 1/4	2 1/2	2 3/4	3
UPC No.	62120	62122	62124	62126	62128

MOCCASIN AWLS



Diamond point

Osborne No. M32 & M34

Finest quality. 2 sizes available. Packed and sold by dozen.

No.	Length (inches)	Gauge	UPC No.
M32	3-1/2	10	65200
M34	4	9	65202

SPRING STEEL AWL



○ Round point

Osborne No. 140-A

Finest quality. Spring steel awl. Sharp end curved point. 2-3/8" long. UPC No. 62230. Packed and sold by dozen.



OSBORNE needles and pins have long been considered a standard for fine quality. Experience and efficiency in the art of needle making for over one hundred and eighty five years have produced the dependable tools well known throughout the trade as **OSBORNE NEEDLES AND PINS**.

The uniform quality of our needles and pins is carefully maintained by the consistent efforts of the skillful crafts people who make them.

QUOTATION FOR SPECIAL NEEDLES AVAILABLE UPON REQUEST.

OSBORNE needles are gauged by the Standard Wire Gauge as the table illustrates. The gauge sizes are also listed in thousandths of an inch and millimeter sizes.

OSBORNE NEEDLE GAUGES

Actual diameter of wire	English gauge	Decimal equiv. (inch)	Decimal equiv. (mm)
	5	.212	5.385
	5 1/2	.202	5.130
	6	.192	4.877
	7	.176	4.470
	7 1/2	.168	4.267
	8	.160	4.064
	9	.144	3.658
	10	.128	3.251
	11	.116	2.946
	11 1/2	.110	2.794
	12	.104	2.642
	13	.092	2.337
	14	.080	2.032
	15	.072	1.829
	16	.064	1.626
	17	.056	1.422
	18	.048	1.219
	19	.040	1.016
	20	.036	0.914
	21	.032	0.813
	22	.028	0.711
	23	.024	0.610

Curved needles are listed in this catalog according to length (over all) from eye to point. The bottom lines in the following table of measurements also gives the shortest distance (across) from eye to point.

2	2 1/2	3	3 1/2	4	5	6	7	8	9	10	inches over all
1 1/2	1 3/4	2	2 3/8	2 1/4	3 3/8	4	4 3/4	5 1/4	6	6 3/4	inches across



OSBORNE

STRAIGHT NEEDLES

Osborne leather, upholsterer's and hardware needles have long been considered the world standard for fine quality. These needles are manufactured from the finest wire to Osborne's exacting quality.

HARNES NEEDLES



Osborne No. 517

Packed 25 needles per paper.

Size No.	000	00	0	1	2	3	4	5	6	7
Length (in)	2 3/8	2 3/8	2 3/8	2 3/8	2 1/4	2 1/8	1 7/8	1 7/8	1 9/16	1 5/8
Gauge	16	17	18	19	19	20	20	21	21	22
UPC No.	15672	15674	15676	15678	15680	15682	15684	15686	15688	15690

GLOVERS' NEEDLES



Osborne No. 518

Packed 25 needles per paper.

Size No.	000	00	0	1	2	3	4	5	6	7	8
Length (in)	2 5/16	2 1/16	2	1 7/8	1 13/16	1 11/16	1 5/8	1 9/16	1 7/16	1 3/8	1 1/4
Gauge	17	17	18	18	18	19	19	20	20	22	22
UPC No.	15712	15714	15716	15718	15720	15722	15724	15726	15728	15730	15732

**HARNES NEEDLE - BLUNT POINT
Osborne No. 559-5**



Length (inches)	Gauge	UPC No.
5	10	15700

Packed 25 needles per paper.

**PEARL SEWING NEEDLES
Osborne No. 561**



Size (mm)	Diameter (mm)	UPC No.
30	0.40	15762
40	0.45	15764

Packed 25 needles per paper.

**TAPESTRY NEEDLES - Blunt point
Osborne No. 563**

Packed 25 needles per paper.

Actual size	Size No.	UPC No.
	13	15842
	14	15844
	16	15846
	18	15848
	20	15850
	22	15852
	24	15854
	26	15856

**CHENILLE NEEDLES - Round point
Osborne No. 562**

Packed 25 needles per paper.

Actual size	Size No.	UPC No.
	13	15768
	14	15770
	16	15772
	18	15774
	20	15776
	22	15778
	24	15780
	26	15782

**SMYRNA NEEDLES - Blunt point
Osborne No. 565**

Packed 25 needles per paper.

Actual size	Size No.	UPC No.
	1	15872
	3	15874

**SMYRNA NEEDLES - Round point
Osborne No. 564**

Packed 25 needles per paper.

Actual size	Size No.	UPC No.
	1	15862
	3	15864

PEARL STRINGING NEEDLES - Sharp point

Osborne No. 560-SP

Packed 25 needles per paper.

Size (mm)	Diameter (mm)	UPC No.
100	0.50	15752
125	0.65	15754
100	0.75	15756

PEARL STRINGING NEEDLES - Blunt point

Osborne No. 560-BP

Packed 25 needles per paper.

Size (mm)	Diameter (mm)	UPC No.
100	0.50	15753
125	0.65	15755
100	0.75	15757



OSBORNE

NEEDLES

WEAVING NEEDLES

Osborne No. 52248

These needles have a rounded tip, so they're perfect for sewing on knit fabrics. A sharp needle can easily damage knit fabric by poking through a thread and then pulling out the knit stitches. A ball point, on the other hand, will pass right through the knit. Available in variety of sizes and thickness. Specify when ordering.

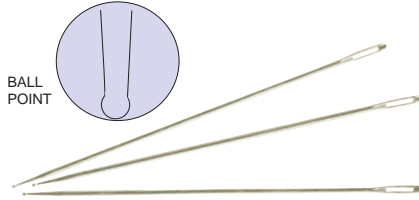

BALL POINT - LIGHT

Size	37	40	44	48	55	62	68	72	76	90	100	110
Length (in)	1.46	1.57	1.73	1.89	2.17	2.44	2.68	2.84	3	3.50	4	4.3
Gauge	23	22	22	22	22	22	22	22	20	18	17	17
UPC No.	14900	14902	14904	14906	14908	14910	14912	14914	14916	14918	14920	14922

BALL POINT - HEAVY

Size	000	002	3/0	5/0	7/0	125
Length (in)	2.91	2.68	3.07	3.54	4.72	4.92
Gauge	18	18	17	16	16	14
UPC No.	14924	14926	14928	14930	14932	14934

Osborne No. 52247

Size	057
Length (in)	2.25
Gauge	18
UPC No.	14910

FOR NYLON

Packed 25 needles per package.

COLLAR NEEDLES - Half moon

Osborne No. 92 1/2



Size (in)	3	3 1/2	4	5	6	6 1/2	7 1/2	8 1/2
Gauge	12	11	10	9	9	7	6	7
UPC No.	15876	15880	15882	15878	15884	15886	15888	15890

Packed 12 needles per package.

STAINLESS STEEL SERPENTINE NEEDLES

Osborne No. 523

Fine quality stainless steel needle. Triangular sharp cutting edge. Nickel plated. Great for sewing heavy hides where you need a good grip on the needle. 4 sizes available.



Osborne No.	Overall ((inches)	Flat Gauge	Oval Gauge	UPC No.
523 3-1/4	3 1/4	18	15	14942
523 4	4	16	16	14944
523 5-1/2	5 1/2	16	13	14946
523 6	6	15	13	14948

Packed 12 needles per package.

STAINLESS STEEL LOOPUYTS NEEDLES

Osborne No. 524

Fine quality stainless steel needle. Triangular sharp cutting edge. Nickel plated. Designed for good grip and ease in use. Won't wear your hands after hours of sewing. Great for light to heavy skins. 4 sizes available.



Osborne No.	Distance "A" (inches)	Flat Gauge	Oval Gauge	UPC No.
524-1	2 5/8	18	16	14950
524-2	2 1/4	19	18	14952
524-3	1 3/4	20	19	14954
524-4	1 1/2	20	19	14956
524-5	1 3/8	20	19	14958

Packed 12 needles per package.

BIRD PELT NEEDLES

Osborne No. 519

Fine quality steel. Curved triangular outside spine point. Ultra thin gauges. 2 sizes available.



Osborne No.	Overall ((inches)	Flat Gauge	Oval Gauge	UPC No.
519 1-1/2	1 1/2	23	20	15742
519 3	3	19	17	15744

Packed 12 needles per package.



OSBORNE

NEEDLES & PINS

CARPET NEEDLES - Round point



Size (in.)	1 7/8	2 1/8	2 1/2	3
Gauge	18	17	17	16
UPC No.	15652	15654	15656	15658

Osborne No. 515

Packed 25 needles per package.

CARPET NEEDLES - 3 Square point



Size (inches)	Gauge	UPC No.
2 - 1/2	17	15666

Osborne No. 516

Packed 25 needles per package.

REGULATOR - With eye



Extra light			Light			Heavy		
Size No.	Gauge	UPC No.	Size No.	Gauge	UPC No.	Size No.	Gauge	UPC No.
6	11	16052	6	9	16032	6	6	16042
8	10	16054	8	9	16034	8	5	16044
10	10	16056	10	8	16036	10	5	16046
			12	7	16038	12	5	16048

Osborne No. 306 1/2

Packed 12 regulators per package.

REGULATOR - With plastic handle Osborne No. 520



Length (inches)	6	8	10	12
UPC No.	66062	66064	66066	66068

SILK & BILLARD NEEDLES - Round point

Osborne No. 521-40MM

Size (in.)	Gauge	UPC No.
1 9/16	23	24260

Packed 12 needles per package.

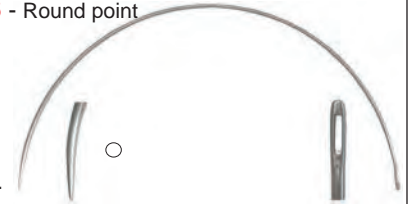

LOOP HEAD PINS



Osborne No. 190

Size (inches)	Gauge	UPC No.
2 1/2	16	15930
3	16	15932
3 1/2	16	15934
4	16	15936

Osborne No. 190S

Special packing 3 dz. to a box		
Size (inches)	Gauge	UPC No.
3	16	15942
3 1/2	16	15944

Packed per gross.

"T" PINS



Osborne No.	Length (inches)	UPC No.	Osborne No.	Length (inches)	UPC No.
189-16	1	15910	189-28	1 3/4	15915
189-20	1 1/4	15912	189-32	2	15916
189-24	1 1/2	15914			

Osborne No. 189

Packed 1/2 lb. to a box.

PLASTIC HEAD PINS



Osborne No.	Color	Length (inches)	Weight per box (oz)	UPC No.
193-B	Blue	2 1/8	4	15962
193-G	Green	2 1/8	4	15970
193-R	Red	2 1/8	4	15964
193-Y	Yellow	2 1/8	4	15966
193-W	White	2 1/8	4	15968

Osborne No. 193

Packed 100 per box.

STRAIGHT PINS Osborne No. 198



Packed 1 lb. to a box.

Osborne No.	Length (inches)	UPC No.
198-17	1 1/16	15982
198-20	1 1/4	15984
198-24	1 1/2	15986
198-28	1 3/4	15988
198-32	2	15990

GLASS HEAD PINS



Osborne No. 181

Length (inches)	Weight per box (oz)	UPC No.
1 1/4	1	16020

Packed 100 per box.



OSBORNE

CURVED NEEDLES

CURVED 3 SQUARE POINT - 1 dozen needles per package.



Osborne No. 502X Extra light

Size (in.)	2	2 1/2	3	3 1/2	4
Gauge	21	20	19	18	18
UPC No.	15242	15244	15246	15248	15250

Osborne No. 502 1/2 Light

Size (in.)	2	2 1/2	3	3 1/2	4	5	6	7	8
Gauge	19	18	18	17	17	16	16	15	15
UPC No.	15262	15264	15266	15268	15270	15272	15274	15276	15278

Osborne No. 502 Heavy

Size (in.)	2	2 1/2	3	3 1/2	4	5	6	7	8	10
Gauge	17	17	16	16	15	14	14	14	13	13
UPC No.	15292	15294	15296	15298	15300	15302	15304	15306	15308	15310

CURVED ROUND POINT - 1 dozen needles per package.

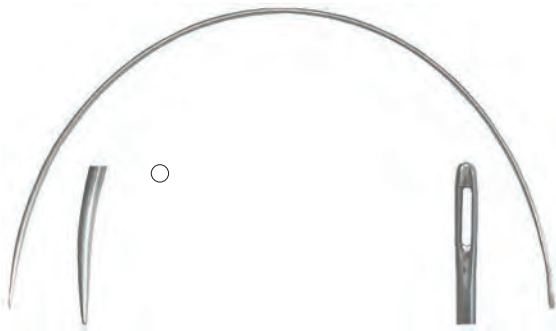

Osborne No. 513X Cord, extra light

Size (in.)	2	2 1/2
Gauge	23	23
UPC No.	15192	15194

Osborne No. 513 Cord, light

Size (in.)	2	2 1/2
Gauge	19	19
UPC No.	15196	15198

Osborne No. 501X Extra light

Size (in.)	2	2 1/2	3	3 1/2	4
Gauge	21	20	19	18	18
UPC No.	15112	15114	15116	15118	15120

Osborne No. 501 1/2 Light

Size (in.)	2	2 1/2	3	3 1/2	4	5	6	7	8
Gauge	19	18	18	17	16	16	15	15	15
UPC No.	15132	15134	15136	15138	15140	15142	15144	15146	15148

Osborne No. 501 Heavy

Size (in.)	2	2 1/2	3	3 1/2	4	5	6	7	8	10
Gauge	17	17	16	16	15	14	14	14	13	13
UPC No.	15162	15164	15166	15168	15170	15172	15174	15176	15178	15180

CURVED "LEATHER" POINT - 1 dozen needles per package.
Sharp edges.



Osborne No. 503 Light

Size (in.)	2	2 1/2	3	3 1/2	4	5	6	8
Oval ga.	19	19	16	16	15	15	14	13
Flat ga.	23	23	19	19	19	19	17	17
UPC No.	15322	15324	15326	15328	15330	15332	15334	15336

Osborne No. 553 Heavy

Size (in.)	3	4	5	6	7	8
Oval ga.	15	14	13	13	12	12
Flat ga.	18	17	17	17	14	14
UPC No.	15342	15344	15346	15348	15350	15352

CURVED MATTRESS LONG BAYONET POINT

Similar to Osborne No. 503 & 553 but edges are hand polished. Sharp edges.
1 dozen needles per package.



Osborne No. 409

Size (in.)	4	8
Gauge	15	14
UPC No.	15232	15234

LAMP SHADE - ROUND POINT

1 dozen needles per package.

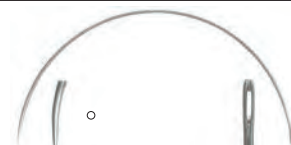

Osborne No. 741

Size (in.)	2	2 1/2	3	3 1/2	4
Gauge	21	21	21	19	19
UPC No.	15212	15214	15216	15218	15220



OSBORNE

STRAIGHT NEEDLES

STRAIGHT SINGLE ROUND POINT 12 needles per package.



Osborne No. 504

Size (in.)	4	5	6	8	10	12	14	16	18
Gauge	15	14	14	14	13	13	13	12	12
UPC No.	15362	15364	15366	15368	15370	15372	15374	15376	15378

Osborne No. 554

Size (in.)	6	8	10	12	14	16	18	BOLSTER NEEDLE 24
Gauge	13	13	12	12	12	11	11	11
UPC No.	15386	15388	15390	15392	15394	15396	15398	15400

STRAIGHT DOUBLE ROUND POINT 12 needles per package.



Osborne No. 505

Size (in.)	6	8	10	12	14	16	18	20
Gauge	14	14	13	13	13	12	12	12
UPC No.	15412	15414	15416	15418	15420	15422	15424	15426

Osborne No. 555

Size (in.)	6	8	10	12	14	16	18
Gauge	13	13	12	12	12	11	11
UPC No.	15432	15434	15436	15438	15440	15442	15444

STRAIGHT SINGLE 3 SQ. POINT 12 needles per package.



Osborne No. 506

Size (in.)	6	8	10	12	14	16	18
Gauge	14	14	13	13	13	12	12
UPC No.	15452	15454	15456	15458	15460	15462	15464

Osborne No. 556

Size (in.)	6	7	8	10	12	14	16	18
Gauge	13	13	13	12	12	12	11	11
UPC No.	15472	15473	15474	15476	15478	15480	15482	15484

FLOCKING NEEDLES 12 needles per package.



Osborne No. 514

Size (in.)	6	7	7	8	8	10
Gauge	12	12	11	12	11	11
UPC No.	15632	15634	15636	15638	15640	15642

STRAIGHT DOUBLE 3 SQ. POINT 12 needles per package.



Osborne No. 507

Size (in.)	6	8	10	12	14	16	18
Gauge	14	14	13	13	13	12	12
UPC No.	15492	15494	15496	15498	15500	15502	15504

Osborne No. 557

Size (in.)	6	8	10	12	14	16	18	20
Gauge	13	13	12	12	12	11	11	11
UPC No.	15512	15514	15516	15518	15520	15522	15524	15526

SAILMAKERS' 25 needles per package.



Osborne No. 509

Size (gauge)	9	10	11	12	13	14	15	16	17
Length (in)	4	3 3/4	3 1/2	3 1/4	3	2 3/4	2 1/2	2 3/8	2 1/4
UPC No.	15612	15614	15616	15618	15620	15622	15624	15626	15628

BENT PACK (2 views) 12 needles per package.



Osborne No. 508

Size (in.)	3	3 1/2	4	5	6	7	8	9	10
Gauge	14	13	12	10	9	7	6	5	4
UPC No.	15552	15554	15556	15558	15560	15562	15564	15566	15568

SPRING EYE STRAIGHT PACK (WITH CUTTER) 12 needles per package.



Osborne No. 508-1/2 SE

Size (in.)	4	4 1/2	4	5	5	6	6
Gauge	7	7	8	5	7	5	7
UPC No.	15582	15581	15588	15583	15584	15585	15586



All cellophane and plastic used on Osborne needle cards is biodegradable.

HOUSEHOLD REPAIR KIT



Osborne No. K-1

The hallmark blue and yellow case contains an assortment of professional grade needles. Useful in all applications but "hard-to-find" at your regular source of supply. Kalamazoo hole for hang up display. Plastic covered.

Each Kit Contains:	
2 ea.	Curved upholstery needles.
1 ea.	Special bent needle for sewing up fowl sacks or wherever sewing with a string is needed.
1 ea.	Awning or canvas needle - (can be used on sails too).
1 ea.	Carpet or very heavy material needle.
Weight/box	16 oz.
UPC No.	15012

CURVED ROUND POINT



Osborne No. K-3

4 round point needles in the followings sizes: 3", 4", 5" & 6" long to a card. Kalamazoo hole for hang up display. Plastic covered.

Kits per box	Weight per box (oz)	UPC No.
12	6	15014

CURVED 3 SQUARE POINT



Osborne No. K-4

4 three-square point needles in the followings sizes: 3", 4" 5" & 6" long to a card. Kalamazoo hole for hang up display. Plastic covered.

Kits per box	Weight per box (oz)	UPC No.
12	6	15016

CURVED ROUND POINT X-LIGHT



Osborne No. K-7

4 extra light round point needles in the followings sizes: 2 1/2", 3", 3 1/2" & 4" long to a card. Kalamazoo hole for hang up display. Plastic covered.

Kits per box	Weight per box (oz)	UPC No.
12	4	15020

ALL CARDS ARE PACKED 12 CARDS PER BOX AND BOXES CANNOT BE BROKEN



All cellophane and plastic used on Osborne needle cards is biodegradable.

STRAIGHT ROUND POINT



Osborne No. K-5

Four straight round point needles sizes 6", 8", 10" and 12" to a card. Each card printed in attractive yellow and blue and is in sealed plastic pouch. Kalamazoo hole for hang up display.

Kits per box	Weight per box (oz)	UPC No.
12	18	15018

STRAIGHT DOUBLE ROUND POINT



Osborne No. K-6

3 straight double round point needles sizes 10", 12" & 14" to a card. Each card printed in attractive yellow and blue and sealed in plastic pouch. Kalamazoo hole for hang up display.

Kits per box	Weight per box (oz)	UPC No.
12	18	15010

STRAIGHT DOUBLE 3 SQAURE POINT



Osborne No. K-8

3 straight double triangular point needles sizes 10", 12" & 14" to a card. Each card printed in attractive yellow and blue and sealed in plastic pouch. Kalamazoo hole for hang up display.

Kits per box	Weight per box (oz)	UPC No.
12	18	15008

ALL CARDS ARE PACKED 12 CARDS PER BOX AND BOXES CANNOT BE BROKEN



All cellophane and plastic used on Osborne needle cards is biodegradable.

NEEDLE CARD



Osborne No. K-10

Each kit contains 20 sewing needles, 10 Darners and 1 Threader. Kalamazoo hole for hang up display. Nickel plated.

Kits per box	Weight per box (oz)	UPC No.
12	4	15022

NEEDLE CARD



Osborne No. K-11

Each kit contains 25 assorted hand sewing needles. 10 each # 7, 10 each # 5 and 5 each # 3. Kalamazoo hole for hang up display. Nickel plated.

Kits per box	Weight per box (oz)	UPC No.
12	4	15028

NEEDLE CARD



Osborne No. K-12

Each kit contains 5 Chenille and 5 Tapestry needles. 1 each # 18, 2 each # 20 and 2 each # 22. Kalamazoo hole for hang up display. Nickel plated.

Kits per box	Weight per box (oz)	UPC No.
12	4	15034

NEEDLE CARD



Osborne No. K-15

Each kit contains 12 Assorted Darners needles, sizes 0/5. Kalamazoo hole for hang up display. Nickel plated. Kalamazoo hole for hang up display. Nickel plated.

Kits per box	Weight per box (oz)	UPC No.
12	4	15040

ALL CARDS ARE PACKED 12 CARDS PER BOX AND BOXES CANNOT BE BROKEN